

Stands

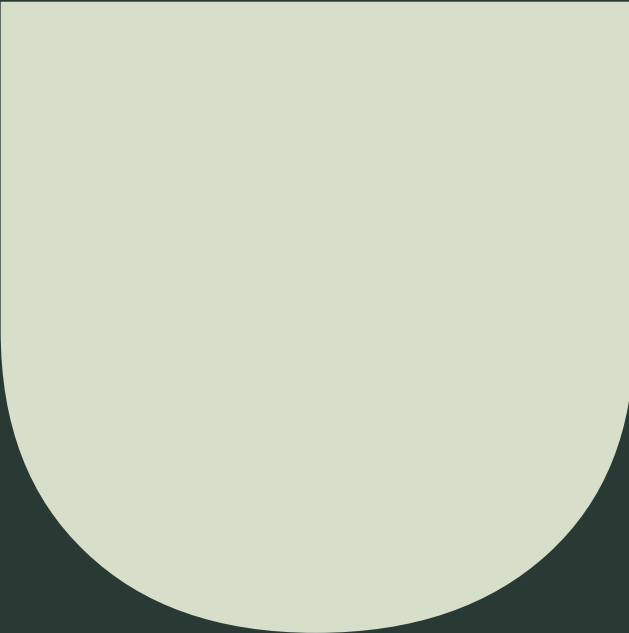
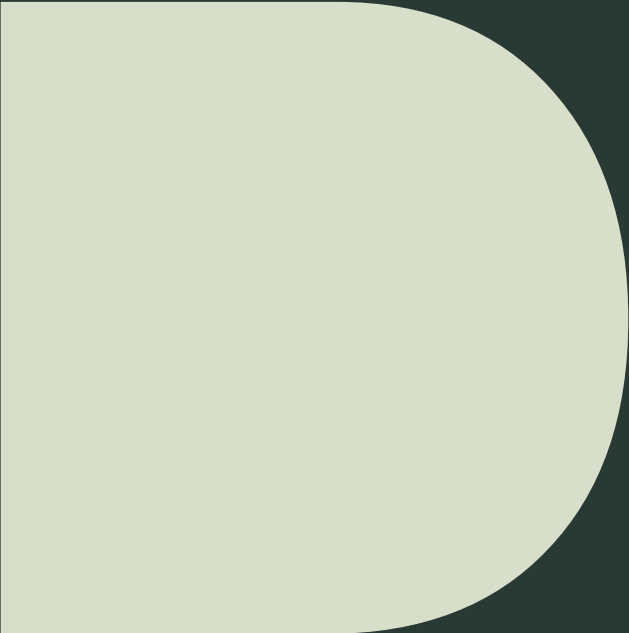

We are constantly improving and adding to our product range and reserve the right to modify their specifications and prices without prior notice.

Although this document has been produced with care, it may contain errors or omissions which are not binding on those who distribute this catalogue. Only the final quote is valid.

We also encourage you to review the General Terms and Conditions of Sale of this catalogue's distributor.

The brands and logos shown in this catalogue are the property of their respective owners and are only used as presentation suggestions.

introduction
& new products

4

contour.
portable
tubular stands

13

Portable tubular contour stands

panoramic®
h-line
modular
stands

30

Panoramic h-line modular stands / panoLED LED video walls

panoramic®
c-line
custom
stands

60

Panoramic c-line custom stands / panoLED LED video walls

Stand
Add-ons

72

Hanging signs / lighting / printed carpet /
brochure holders & display cases

tips &
tricks

80

summary

Our purpose: create, design and build stands that meet your needs

- Are you looking for unique, high-impact stand solutions?

All of our solutions are created to put the spotlight on your message.

The structures, textiles and printing techniques have been developed conjointly. The results: high quality and exceptional impact that helps showcase your image.

The endless combinations possible between panels and accessories ensure that your stand is unique.



- Are you an agile company looking for solutions tailored to your own pace?

A company stands 5 times a year* on average. This is why we design changeable, modular and reconfigurable stands with endless possibilities.

A range of optional accessories are also available to make them even more functional.

* Source : French study by Unimev - "Salons et Foires : un puissant outil de développement pour les entreprises"



Viscom Paris



Viscom Frankfurt



EDPA Orlando



CIPrint Lyon

Our environmental approach guarantees you the most eco-friendly products

Throughout the entire life cycle of our products, we implement concrete actions with our network to minimize environmental impact.

Our eco-responsible approach takes the form of five commitments that are carried out throughout the entire life cycle of our products:

- 1 Opt to use recyclable, recycled, biodegradable or repairable (i.e. no definitive assembly) raw materials and finished products whenever possible. Ensure that only the essential elements for desired features are used, i.e. no unnecessary parts.
- 2 Minimize the impact of manufacturing on the environment by using more eco-friendly machinery and optimizing the production process. Notably, our 1158 solar panels (2252 square meters) installed on the rooftop of our factory in France allow us produce 313 MW per year (for lower consumption: 301).
- 3 Reduce environmental impact with local production and distribution centers. We produce and store next to the exhibition places (3 production facilities worldwide: France - Germany - Canada ; and logistics centers close to major cities)
- 4 Encourage the reuse of our solutions. All of our frames can be used for several events.
- 5 Oversee the recycling of raw materials and final products, or the transformation of non-recycled graphics into objects. For example, aluminum is systematically recycled, and we have created partnerships with local charitable associations to reuse graphics as textiles.

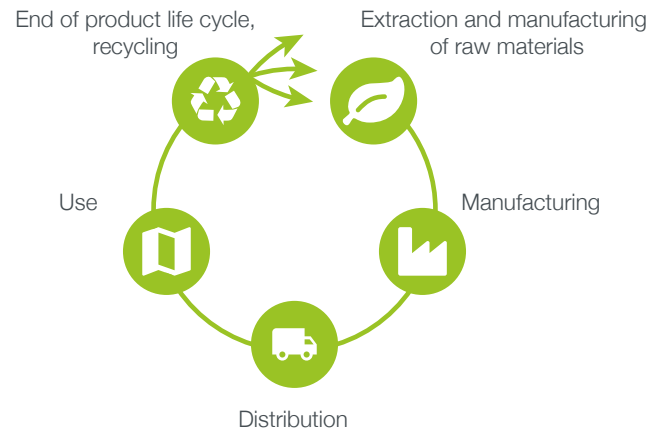

An environmental approach implemented throughout the entire life cycle of our products

Reuse of a stand graphic as a decorative wall frame

Production takes place locally, in France and across Europe, to limit the environmental impact of transport. Overall, we strive to integrate eco-friendly actions into our day-to-day activities and at every level.

Our turnkey offering

Services included for each stand.



STAND DESIGN

Your personalized solution, designed and quoted in 5 days and a viewer link that gives you a 360-degree visualization of your stand online.

FILE MANAGEMENT

An online portal for real time tracking of your order.

MADE LOCALLY

Manufactured and finished by our production facilities, located in France, Germany and Canada.

QUALITY CONTROL

100% of our stands are inspected by our experts.

Our additional services



GRAPHIC CREATION

that boosts your image.

OPTIMIZED LOGISTICS SERVICES

to provide you with the best experience.

STAND INTER- NATIONALLY

thanks to an international network of assemblers available for set-up and dismantle.

STAND RENTALS

a smart economical solution for your occasional needs. A solution tailored to multimedia and LED video walls.

STORAGE SERVICES

for your stands.

Our tools to assist you



PS3D

Your 3D stand design software that allows you to make renderings and estimates for all our products in just a few clicks.

With the viewer extension, see your project online and share it with all collaborators thanks to a unique weblink.

XPO.CENTER

Your personalized and secure file management portal, accessible 24/7. It allows you to access your current or past orders, as well as a summary view of your order status.

With xpo.center, upload your files, then generate and approve your e-proofs in just a few clicks.



Our expertise in dye-sublimation printing on fabric to enhance your communication

- Why choose fabric graphics?

Fabric graphics are very well-suited for use in the exhibit and event industries. They are easy to transport, handle and set up; they are scratch-resistant, wrinkle-free and washable, and may even be dry-cleaned.

They offer unrivaled aesthetic rendering with the best color execution that won't fade over time.

- What is dye-sublimation printing?

Sublimation is a physical phenomenon by which matter passes directly from a solid to a gas. The fabric's fibers are dyed directly, which improves color resistance over time.

- Benefits of this technology

- Unrivaled quality: dye-sub printing offers exceptional contrast, intensity and depth. Colors are vibrant and available in a wide range, including at high density.
- Anti-reflective: dye-sublimated fabric absorbs light and prevents reflections from appearing on your image.
- More eco-friendly process: the inks used are aqueous solutions that are solvent-free and odorless.

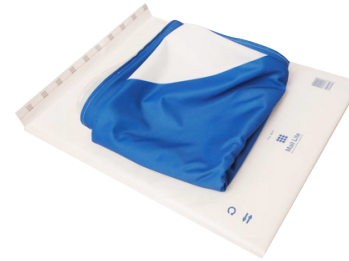

Innovations

Panoramic h-line Lightbox (4 cm)

Thinner, more modular for even more creative possibilities!



Signature spotlight

A more design-focused and higher-performance lighting solution. (see page 72)

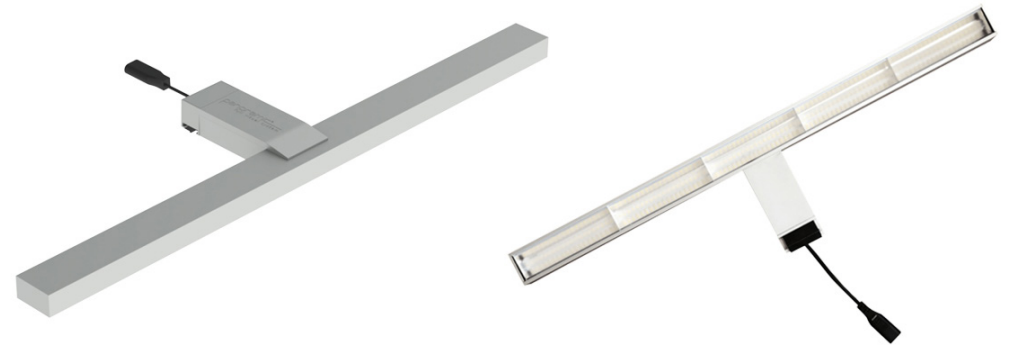

New panoramic h-line transparent modules

Combine 4 transparent partition models to allow light to pass through while remaining hygienic.

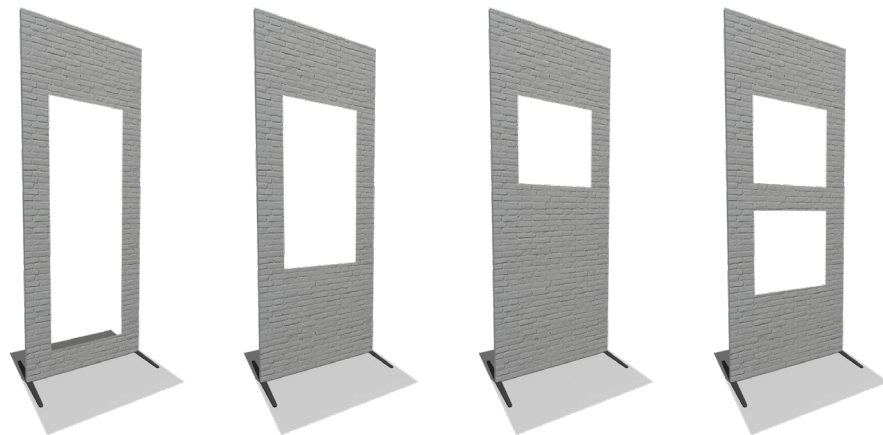

contour

Stand out from the crowd with new contour inclined, curved and wave formats. (see page 18)



Innovations

Panoramic lightbox

Accessories, profile colours and new printed reverse side options for a 100% customized lightbox.



New h-line TV mount for TVs up to 65"

Broadcast your message on bigger screens.

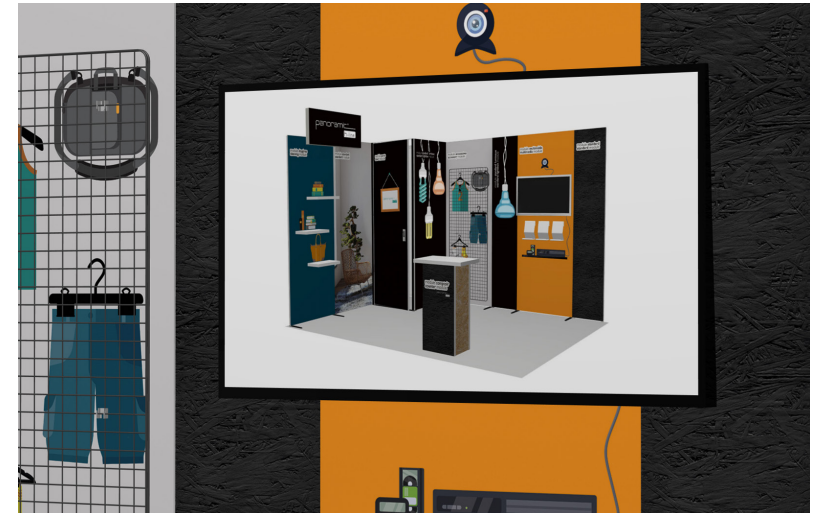

Backlit hanging signs

Communicate with height and light. (see page 71)

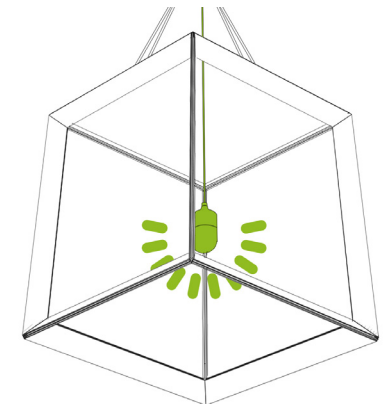

Choose a stand solution to meet your needs!



portable



self set-up

contour.

The high-impact adjustable and portable stand.

- Ideal for spaces from 9 to 27 m²
- Packaged in wheeled transport bags
- Can be assembled by yourself
- Purchase from 500 €

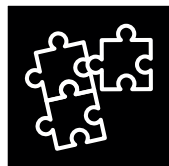
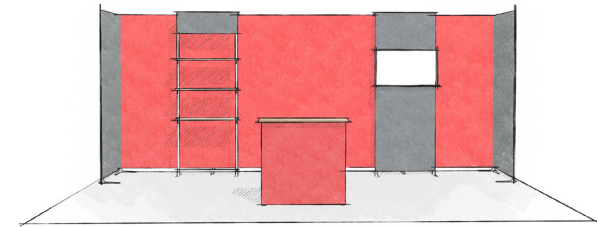

modular

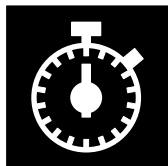

rental

panoramic[®] h-line

Modular solution, endlessly reconfigurable.
Available for purchase or rental.

- Ideal for spaces from 9 m²
- Packaged in a transport crate with wheels, with graphics pre-assembled on the frames
- To be assembled by yourself or by professionals
- Purchase from 6000 € / rental from 3000 €

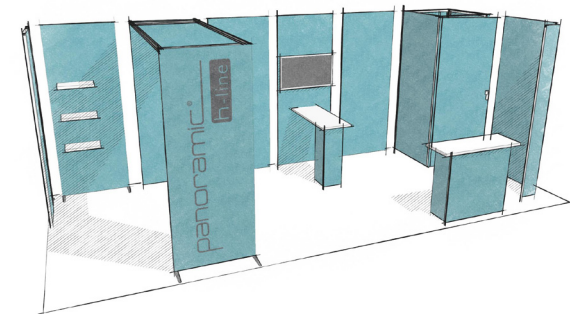

design

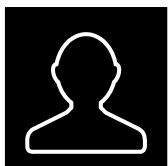

custom

panoramic[®] c-line

Design solution, ideal for custom stands.

- Suitable for all spaces.
- Reusable.
- To be assembled by professionals.

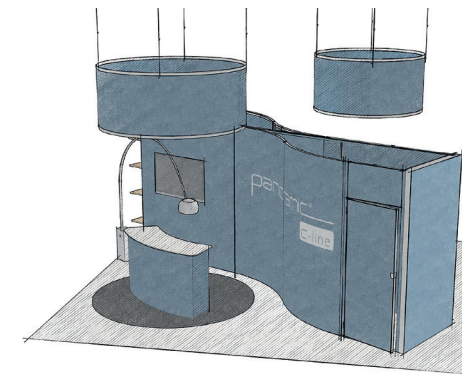

contour.

- Portable stands, recommended for spaces from 9 to 27 m²
- Packaged in wheeled transport bags
- Can be assembled by yourself



portable



self set-up

portable tubular stands

contour, the tubular fabric stand solution

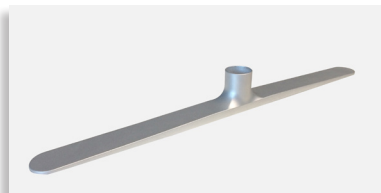

elegant design

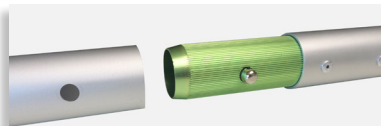

self set-up



frame connectors



wheeled transport bag



optional accessories



- A portable stand solution featuring a tubular structure covered in stretch single-sided or double-sided graphic
- Lightweight and compact: 11 kg for contour.10x8 (2900 x 2340 mm). Transported in a wheeled bag
- Intuitive setup: no tools needed. The connectors snap into the tubes with easy-to-follow guides on each frame
- Dye-sublimation printing for graphic impact: glare-free images, intense and deep colors, wrinkle-free fabric
- For displaying anywhere in the world, thanks to one standard height that is adapted to North American and European standards

contour: standard frames



contour.3x8

Structure + graphic*
+ 1 wheeled transport bag

Dimensions**
900 x 2340 mm



contour.5x8

Structure + graphic*
+ 1 wheeled transport bag

Dimensions**
1450 x 2340 mm



contour.8x8

Structure + graphic*
+ 1 wheeled transport bag

Dimensions**
2340 x 2340 mm



contour.10x8

Structure + graphic*
+ 1 wheeled transport bag

Dimensions**
2900 x 2340 mm



contour.20x8

Structure + graphic*
+ 2 wheeled transport bag

Dimensions**
5800 x 2340 mm



contour.3x10

Structure + graphic*
+ 1 wheeled transport bag

Dimensions**
900 x 3200 mm

*Graphics printed with black back or printed on both sides. ** The dimensions listed are those of the graphics. The feet raise the frame by 6 cm.

contour: standard frames



contour.angled 3x8

Structure + graphic*
+ 1 wheeled transport bag

Dimensions***
900 x 2340 mm



contour.angled 8x8

Structure + graphic*
+ 1 wheeled transport bag

Dimensions***
2340 x 2340 mm

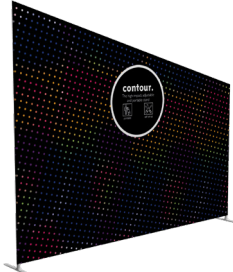

contour.angled 10x8

Structure + graphic*
+ 1 wheeled transport bag

Dimensions***
2900 x 2340 mm



contour.tilted 5x8

Structure + graphic*
+ 1 wheeled transport bag

Dimensions***
1980 x 2340 mm



contour.tilted 8x8

Structure + graphic*
+ 1 wheeled transport bag

Dimensions***
2810 x 2340 mm



contour.curved 8x8

Structure + graphic**
+ 1 wheeled transport bag

Dimensions***
C 2382 x 565 x 2340 mm
S 2445 x 943 x 2340 mm



contour.curved 10x8

Structure + graphic**
+ 1 wheeled transport bag

Dimensions***
C : 2963 x 555 x 2340 mm



contour.wave 8x8

Structure + graphic**
+ 1 wheeled transport bag

Dimensions***
2340 x 2340 x 541 mm



contour.wave 10x8

Structure + graphic**
+ 1 wheeled transport bag

Dimensions***
2900 x 2340 x 541 mm

*Graphics printed with black back or printed on both sides. **Single-sided graphic with black back. ***The dimensions listed are those of the graphics. The feet raise the frame by 6 cm.

contour: options



contour.tv

Structure** + graphic*
+ 1 wheeled transport bag

Dimensions***
900 x 2340 x 300 mm



contour.shelf

Structure + graphic*
+ 1 wheeled transport bag

Dimensions***
900 x 2340 x 300 mm



contour.arch

Structure + graphic*
+ 1 wheeled transport bag

Dimensions***
900 x 2340 x 2340 mm



contour.tv arch

Structure** + graphic*
+ 1 wheeled transport bag

Dimensions***
900 x 2340 x 2340 mm

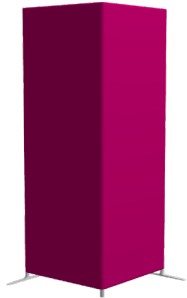

contour.storage corner 3x8

Structure + graphic*
+ 1 wheeled transport bag

Dimensions***
900 x 2340 x 900 mm



contour.storage corner 3x10

Structure + graphic*
+ 1 wheeled transport bag

Dimensions***
900 x 3200 x 900 mm



contour.spot.LED 20W

LED light kit including bag and clip
light support



contour.

Custom frame

Contact us for more information

*Graphics printed with black back or printed on both sides. **TV mounting bracket included. Does not include TV screen. ***The dimensions listed are those of the graphics. The feet raise the frame by 6 cm.

contour is adjustable

Start with a single frame and add more as needed



contour.10x8
+ counter c.air²



contour.8x8



contour.3x8
+ contour.5x8



contour.tv



contour.shelf

9 m²

12 m²

15 m²

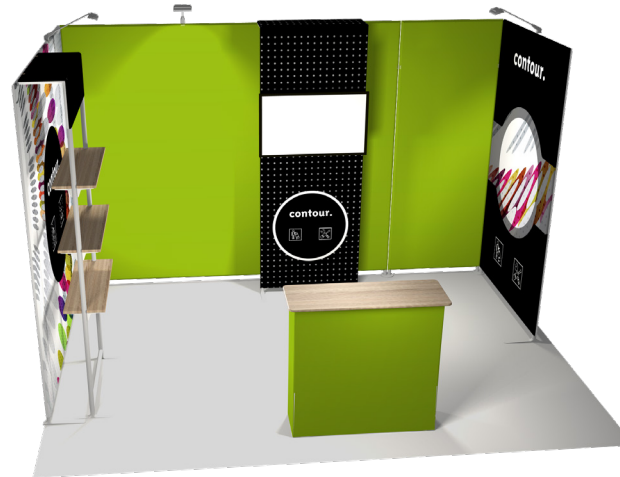
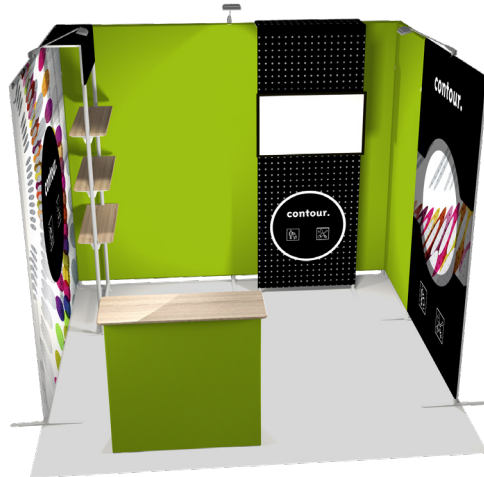



ct-stand-9m2-04

Contact us to request an estimate

Transport solution
Wheeled transport bags

9 m²



Choose the c.air² portable pop-up counter

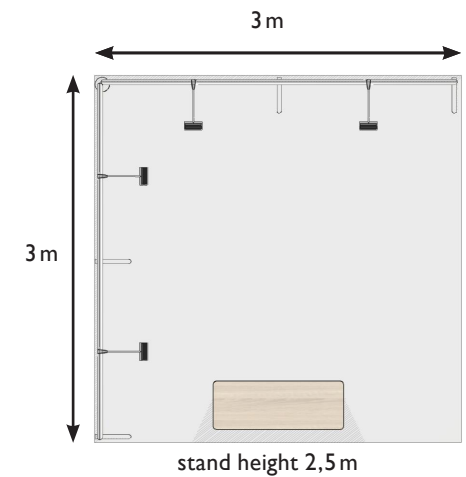



12 m²

ct-stand-12m2-10

Contact us to request an estimate

Transport solution
Wheeled transport bags



Play your videos on the TV frame



Connect your frames at 45° angles to give your stand depth

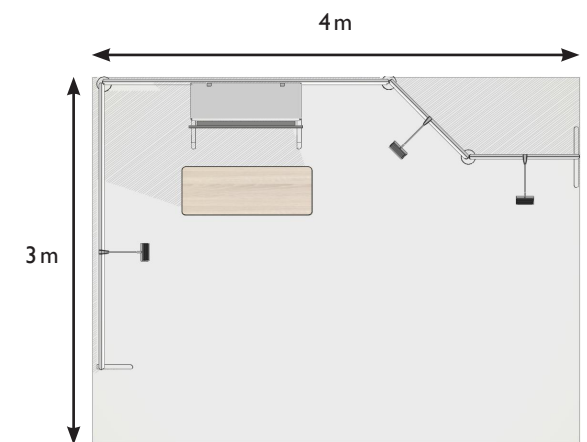

stand height 2,5m



15 m²

ct-stand-15m2-10

Contact us to request an estimate

Transport solution
Wheeled transport bags



Use shelf frames to display your products

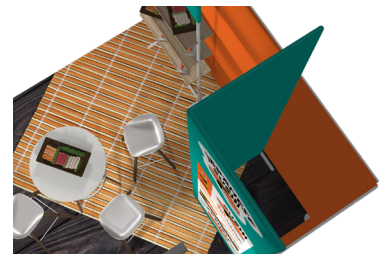

Use the 3x10 storage corner to be visible from far away

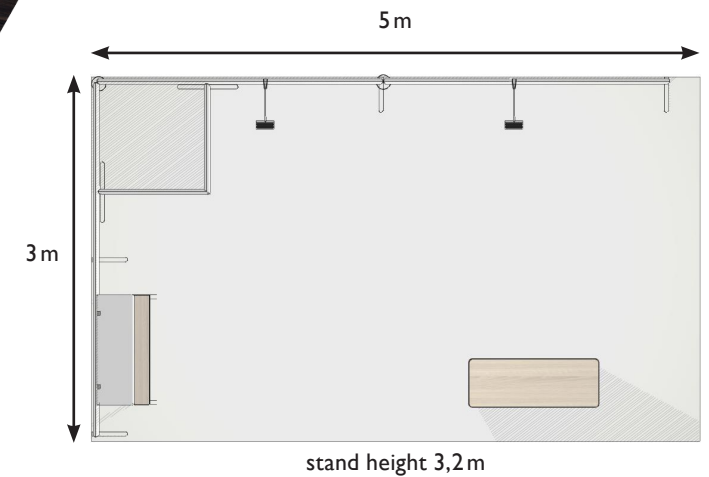



ct-stand-18m2-12

Contact us to request an estimate

Transport solution
Wheeled transport bags

18 m²



Showcase your messages on the TV arch



Large communication areas

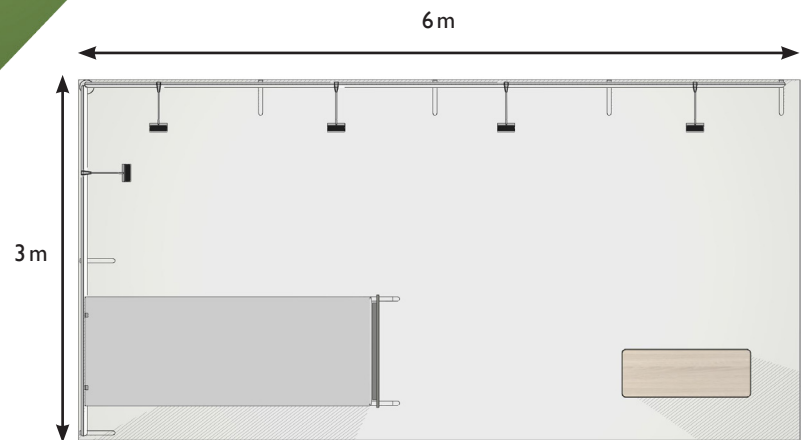

stand height 2,5 m



ct-stand-18m2-13

Contact us to request an estimate

Transport solution
Wheeled transport bags

18 m²

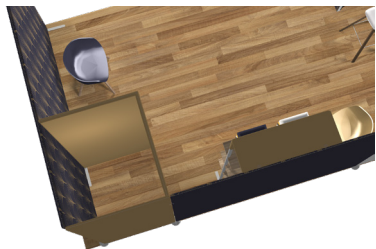

Create a storage area



Place simple feet against partitions

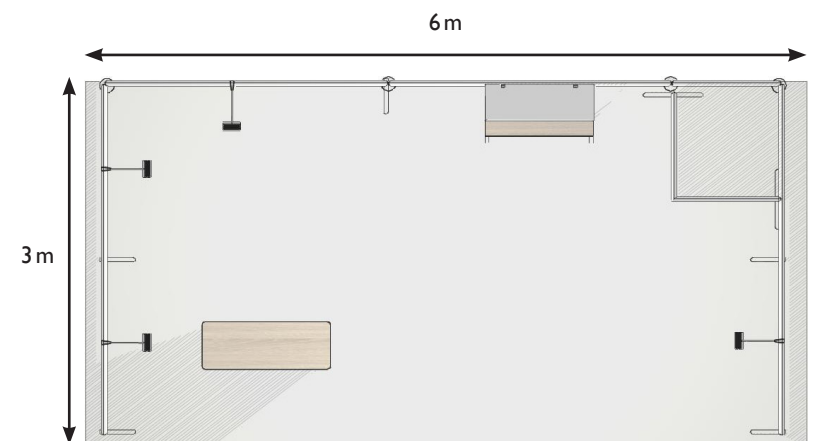

stand height 2,5 m



ct-stand-18m2-14

Contact us to request an estimate

Transport solution
Wheeled transport bags

18 m²



Give your stand character with an arch



Designate a welcome area

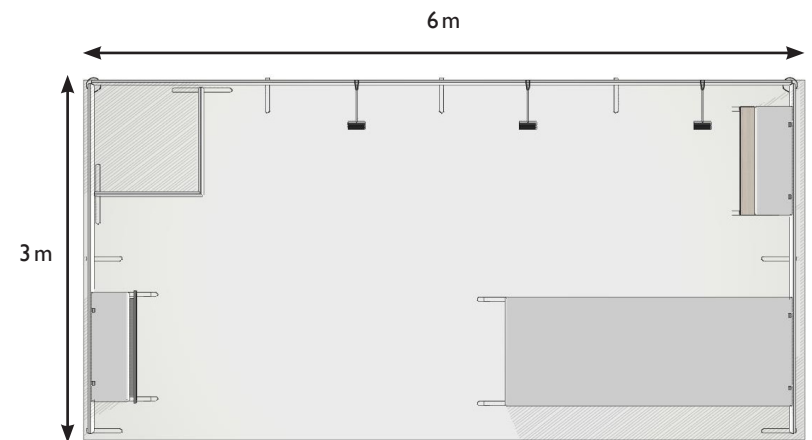

stand height 2,5 m



ct-stand-15m2-11

Contact us to request an estimate

Transport solution
Wheeled transport bags

15 m²



Tilted frames for a unique design



Play your videos on the TV frame

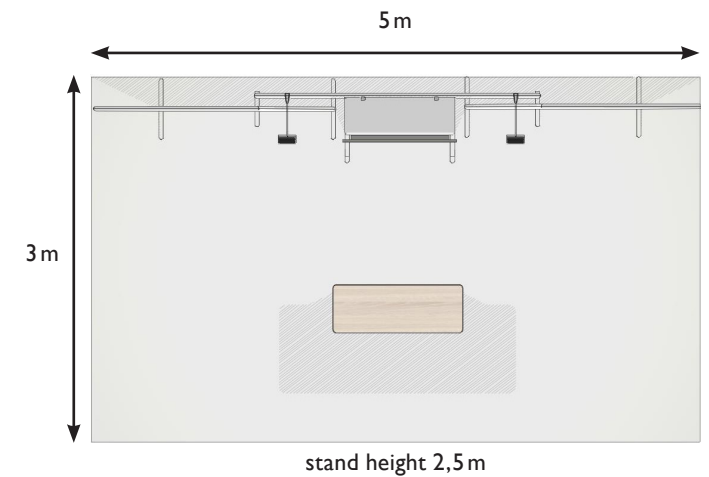



ct-stand-18m2-10

Contact us to request an estimate

Transport solution
Wheeled transport bags

18 m²

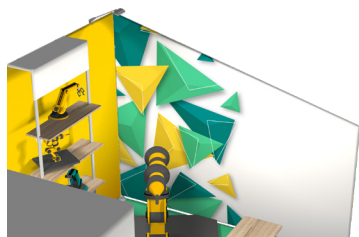

Be original with angled frames



Showcase your messages on the TV arch

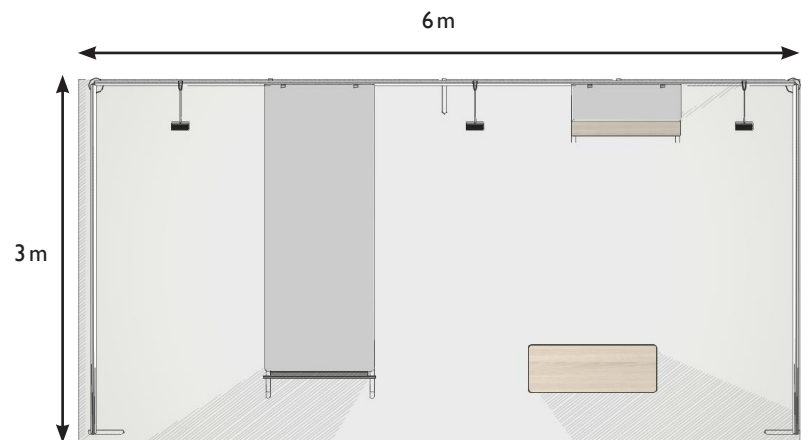

stand height 2,5 m



ct-stand-18m2-11

Contact us to request an estimate

Transport solution
Wheeled transport bags

18 m²

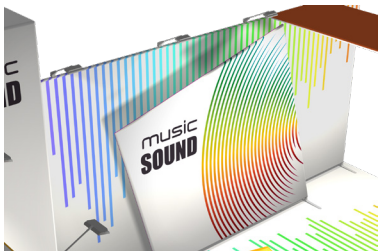

Go bold with inclined lines

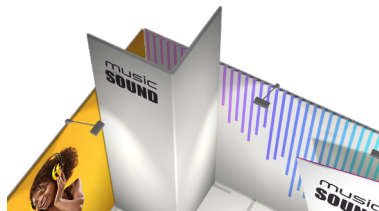

Maximize your visibility

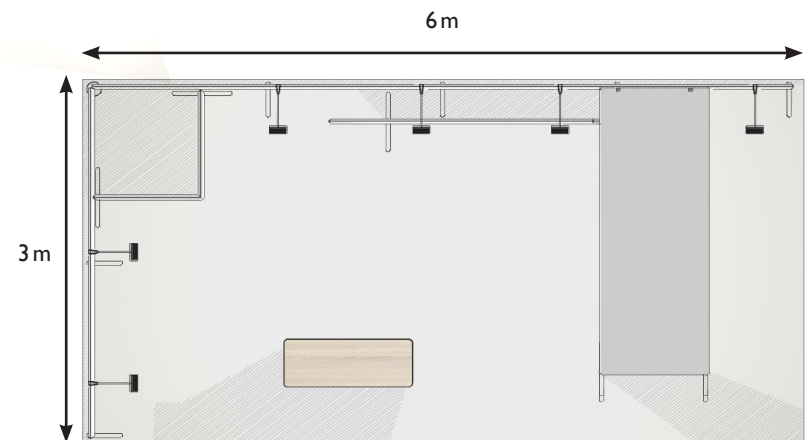

stand height 3,2m

contour: take your creativity with you on-the-go



Photo shoot



Stage backdrop



Stand



Retail promotion



POS advertising



Mall promotion



panoramic[®] h-line

- Modular stands, from 9 m²
- Packaged in a wheeled crate with frames and graphics preassembled
- May be set up with or without professional assistance

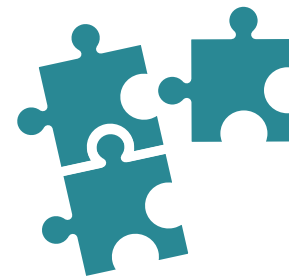

modular

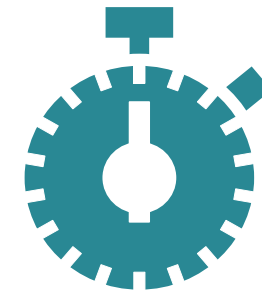

rental

modular stands

The reference of modular stands

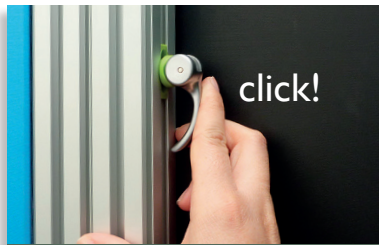

click!

quick panel connector for easy set-up



New: integrate LED video walls



details are a priority



transport crate

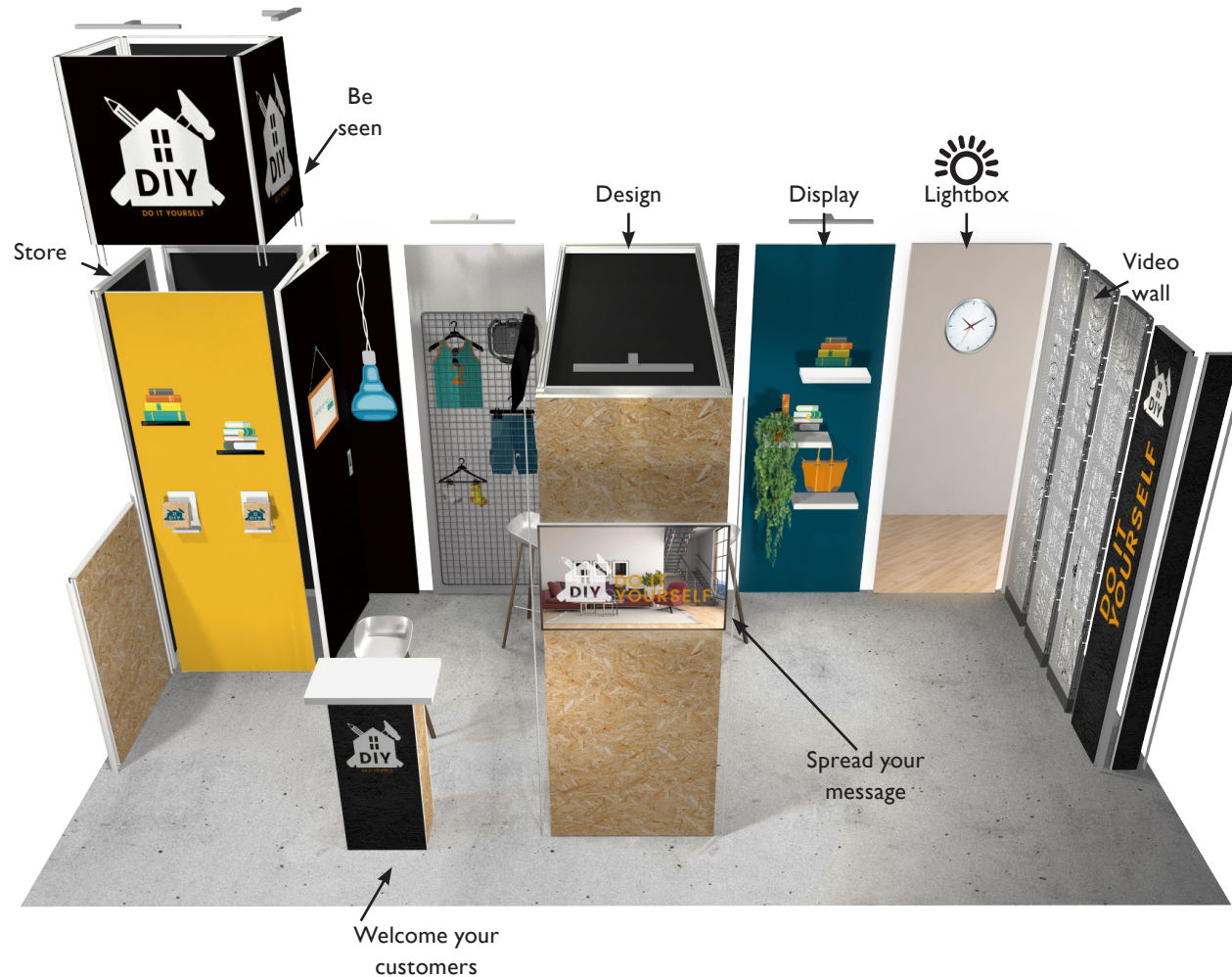

- Create a customized stand using pre-assembled modules that offer a wide range of functionalities
- The visual impact of h-line is created through large format, high-definition fabric graphics. The connections between the panels are invisible
- Panoramic h-line is compatible with panoLED: innovate and bring your stand to life with panoLED video walls
- Set-up time for an 18m² stand is less than an hour

100% modular: 12 modules, 1 transport crate, 4 shows, 4 configurations, 4 locations

Reconfigure your panoramic h-line stand to suit your event, using the same pack of modules each time



100% modular: 12 modules for an unlimited number of configurations!



pack 12 modules

- 2 standard 96 modules - HMS096
- 1 1 m² storage module - HMR096
- 1 USB console module - HMC296B-USB
- 1 3-brochure-holder module - HMF096-01
- 1 shelving module - HME011
- 1 arch module with TV - HMV196B
- 1 right side module - HMA024
- 1 1 m² header module - HMH496
- 1 lightbox signage module - HMHI20-L
- 1 angled pole - HMS004
- 1 M curved counter module - HMC096-C
- 5 LED spotlights
- 1 tablet holder
- 1 storage equipment kit
- 1 stabilizing foot
- 2 electricity kits
- 2 3P power supplies
- 1 h-line emergency kit
- 1 HI transport crate

A function for every module

Standard modules

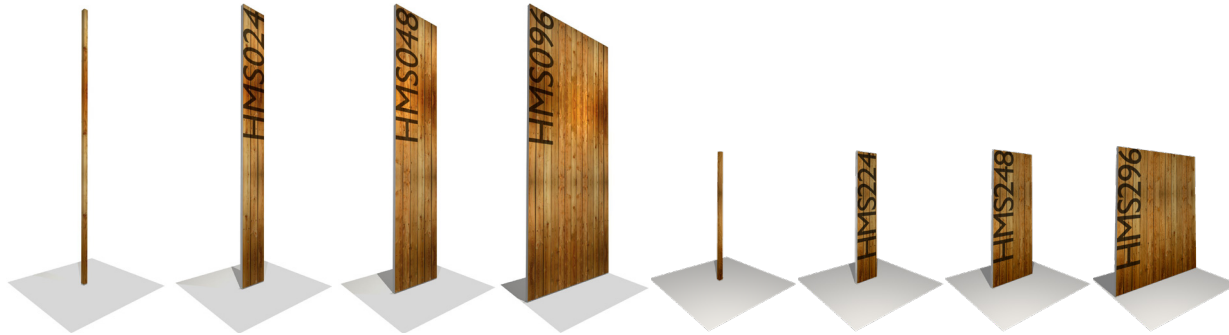

Curved module

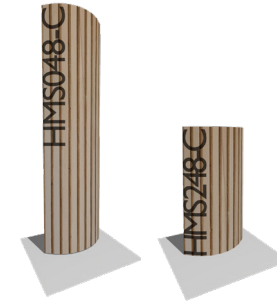

Storage modules



Door module



 Standard lightbox modules



Shelving modules



Optional USB port 

Multimedia modules

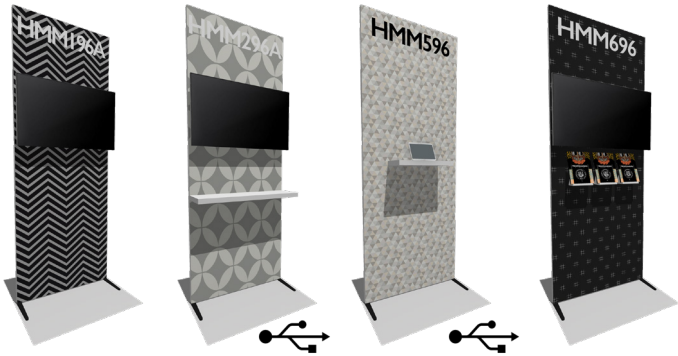

Accessory modules

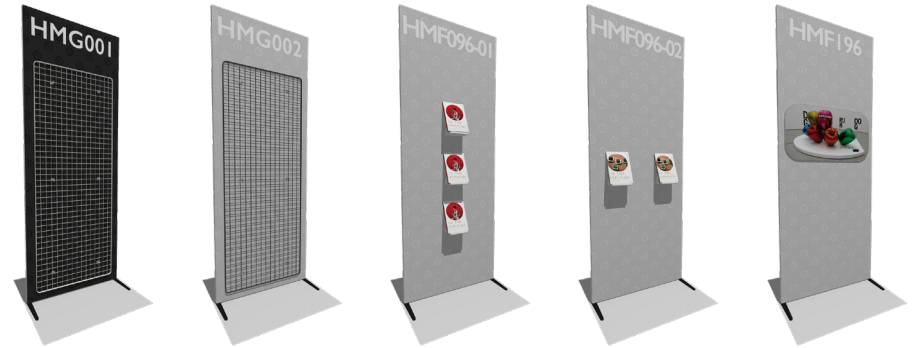

Velum modules



Arch modules

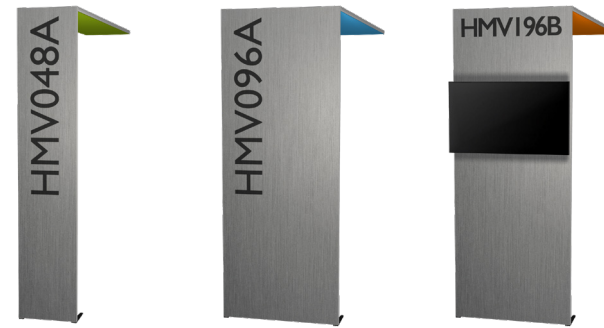

Lightbox arch modules



Curved arch module



Header modules

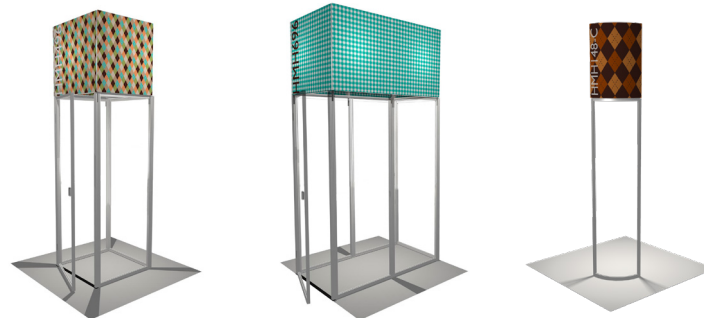

Optional USB port

A function for every module

Side modules

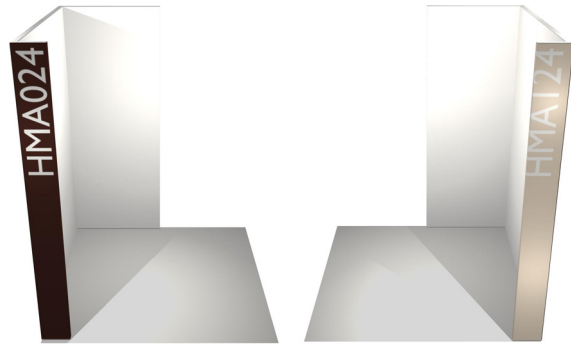

Signage modules & lightbox signs



Console modules 

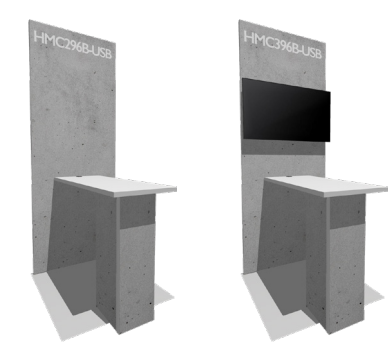

Counter modules 

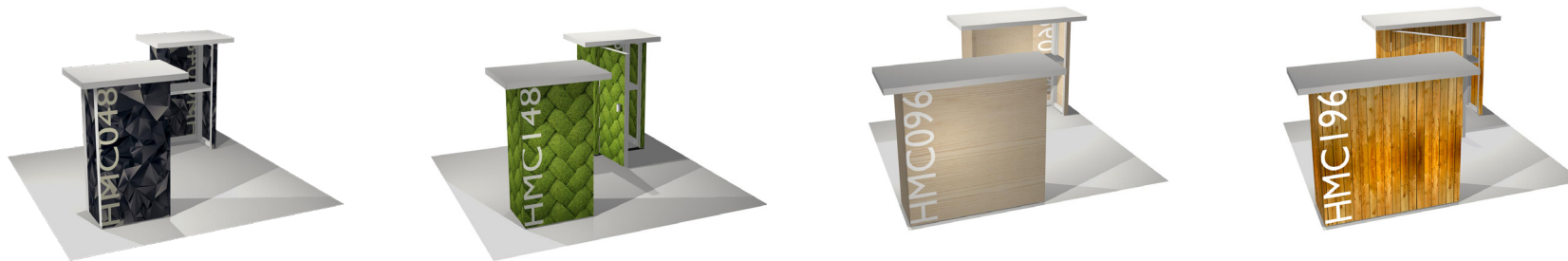

Connecting modules

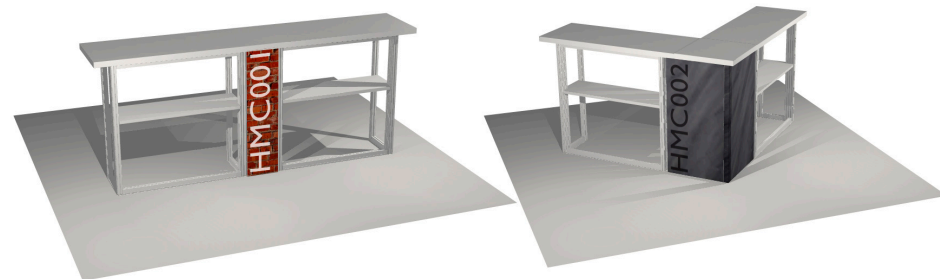

Lightbox counter modules 

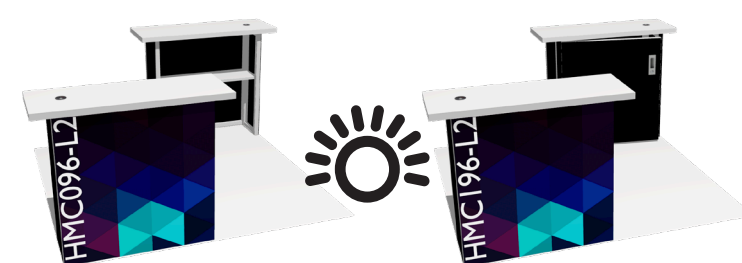

Curved counters

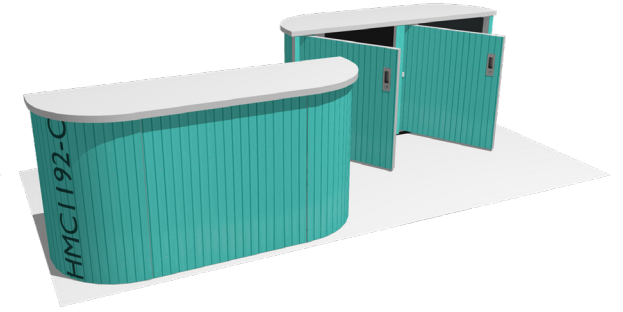
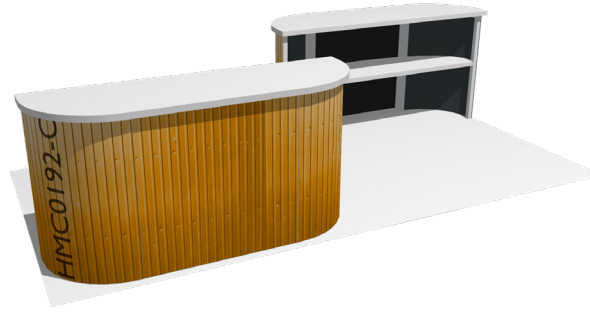
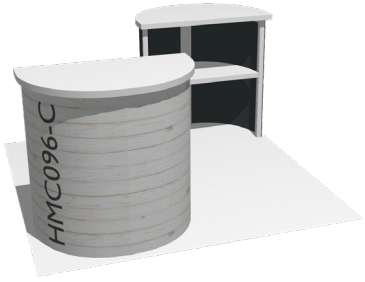

Accessories & Features

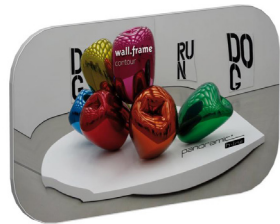
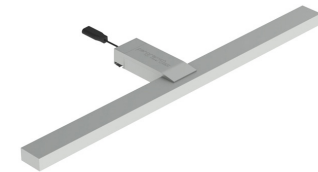

Display cases &
brochure holders
(see p.79)

Optional USB port

For more information, ask for the panoramic h-line brochure

Innovation

Create custom video walls using panoLED LED panels

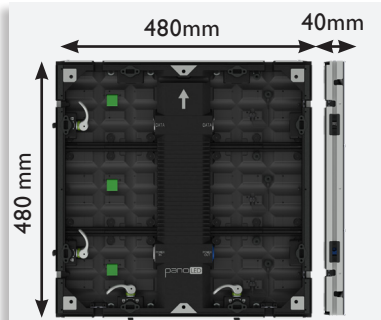

The thinnest and most lightweight panel



Crisp images and vibrant colours



Preinstalled connectors for easy assembly

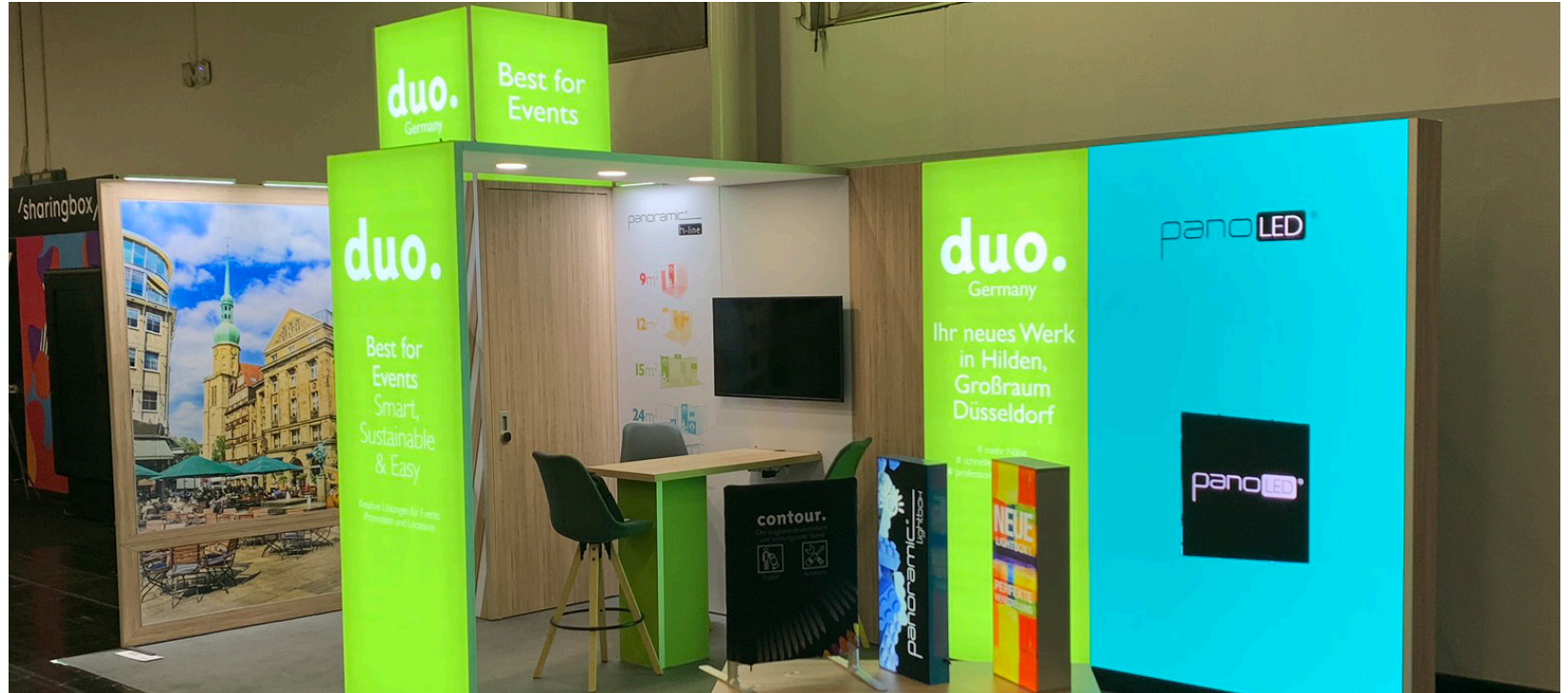

- panoLED lets you create modular video walls by quickly assembling 48 cm x 48 cm panels.
- panoLED lets you innovate and bring your stands to life: reveal the beauty of your content with vibrant colours, spectacular images and a totally new visual experience.
- panoLED offers easy and ultra-secure attachment through the use of preinstalled h-line connectors.
- panoLED is designed to integrate with Panoramic h-line and c-line modular systems, and with conventional stands.
- A silicone edge graphic can be fitted to the reverse side of the panel thanks to a patented innovation (patent pending).
- panoLED allows for applications that go beyond stands: whether hanging, standing or integrated into a design, the applications are endless.



Innovation

panoLED: explore the field of endless possibilities

Stands

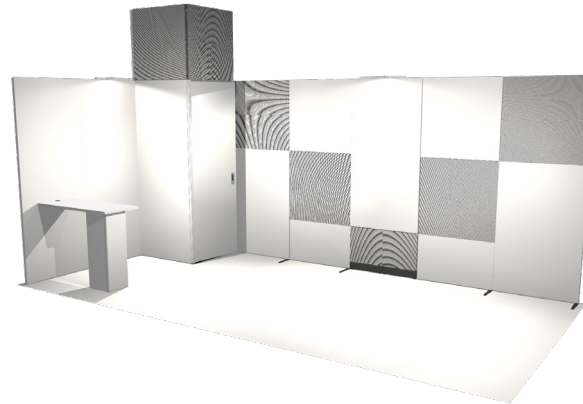

Video walls

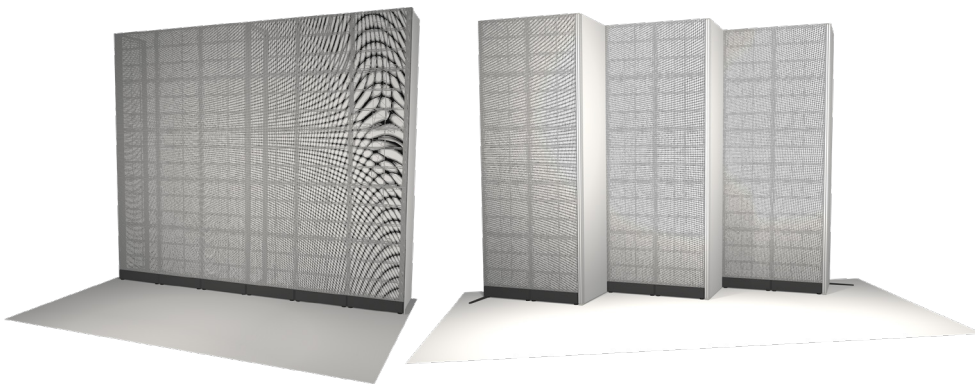

Single-sided or double-sided totem

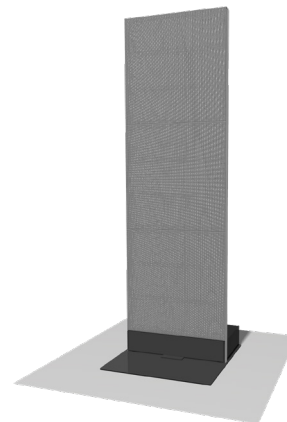

Hanging sign

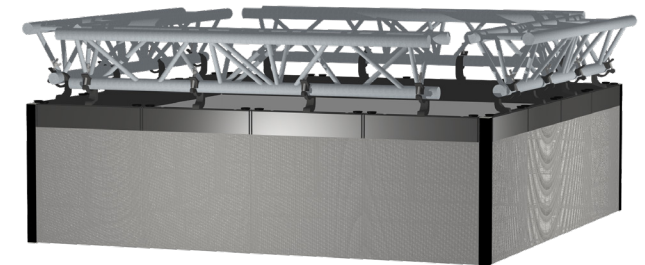



h-stand-9m2-07

Contact us to request a quote for a purchase or rental

Suggested transport solution
1 h-line H2 crate

9 m²

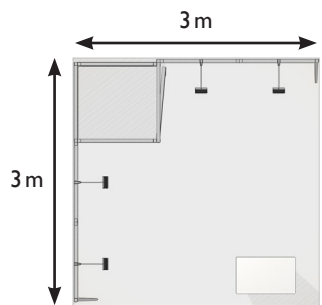

stand height 2,5m



HMC048 counter



1m² equipped storage module
HMR096



Scalable to
12 m²

Add a TV console module
h-stand-12m2-28



h-stand-9m2-30

Contact us to request a quote for a purchase or rental

Suggested transport solutions
 1 h-line H2 crate
 + 1 h-line H7 crate

9 m²

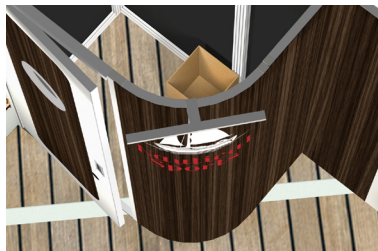
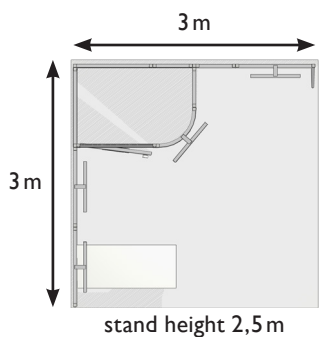

Curved module HMS048-C



Secure, full-option storage with door and porthole

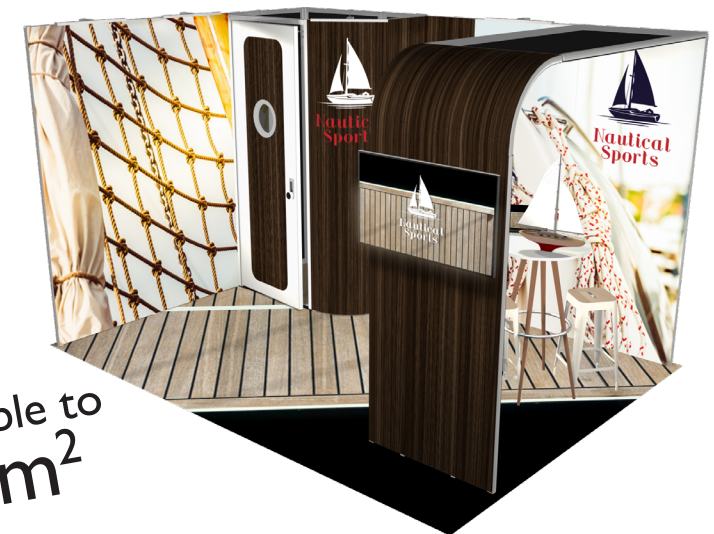

Scalable to
 12 m²

Add a standard 96 module to convert your booth into a 12m²,
h-stand-12m2-34



Signature spotlight for powerful, homogeneous lighting

h-stand-9m2-26

Contact us to request a quote for a purchase or rental

Suggested transport solution
1 h-line H2 crate

9 m²

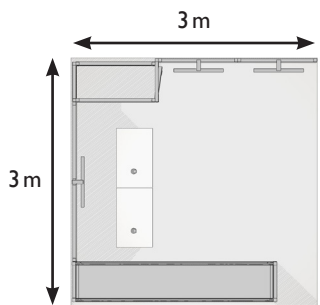

stand height 2,5 m



Create a backlit arch in width of 48cm



Scalable to 12 m²

Simply add a shelf module
h-stand-12m2-30

panoLED



3 x 2,5 m panoLED video wall

h-stand-9m2-28

Contact us to request a quote for a purchase or rental

Suggested transport solution
1 h-line H2 crate
+ 3 flightcases for LED panels

9 m²

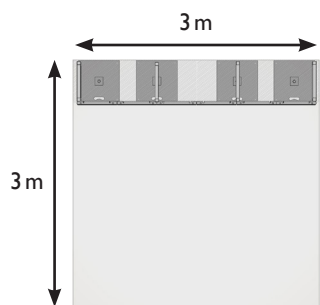

stand height 2,5 m

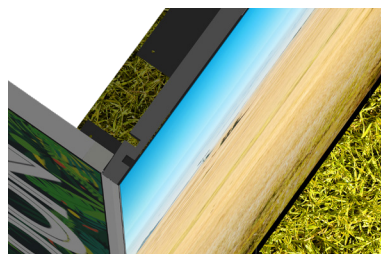

The thinnest panel (40 mm)

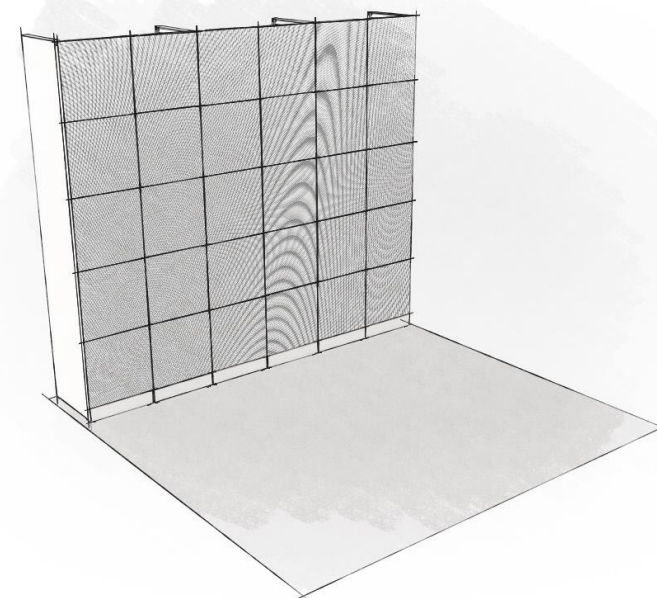



Present your catalogs (brochure holder built into the panel)

h-stand-12m2-31

Contact us to request a quote for a purchase or rental

Suggested transport solution
1 h-line H2 crate

12 m²

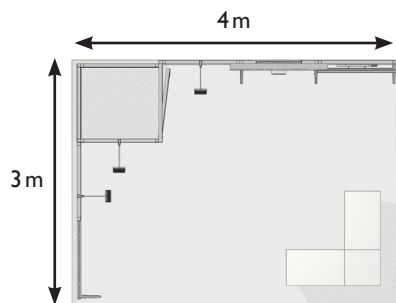

stand height 2,5m



2 counters connected with a corner connection
module HMC002

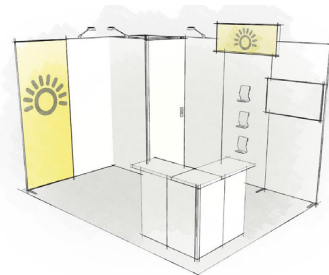

Scalable to
9 m²



Just remove the standard lightbox 96 module
h-stand-9m2-09

Combine different heights to increase impact



12 m²

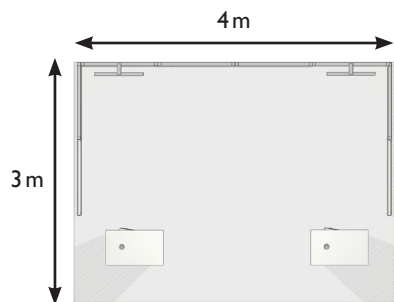

stand height 2,5m



Backlit and non-backlit modules

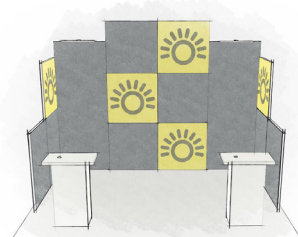

Scalable to 9 m²



Replace 96cm modules with 48cm modules
h-stand-9m2-25

h-stand-12m2-32

Contact us to request a quote for a purchase or rental

Suggested transport solution
1 h-line H2 crate

Get noticed with header module

Create even more impact with a fully backlit arch



h-stand-15m2-12

Contact us to request a quote for a purchase or rental

Suggested transport solution
1 h-line HI crate

15 m²

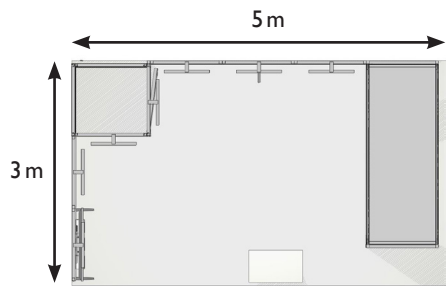

stand height 3,5m



USB hub included in console countertop

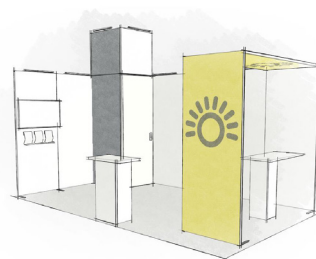

Scalable to 12 m²



Reconfigure your stand by removing one standard 96 module
h-stand-12m2-15



16 m²

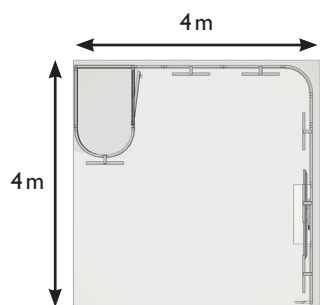

stand height 2,5m

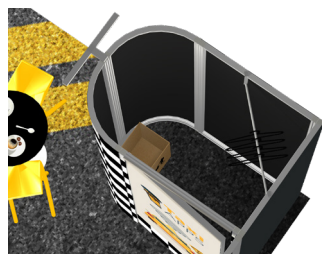

Fully-equipped secure closet
more than 1m²



Signature LED



Opt for a 65" TV

h-stand-16m2-03

Contact us to request a quote for a purchase or rental

Suggested transport solutions
1 h-line H2 crate
+ 1 h-line H7 crate

Broadcast your message on
panoLED video walls



h-stand-16m2-01

Contact us to request a quote for a purchase or rental

Suggested transport solution
3 flightcases for LED panels
+ 1 h-line H2 crate

16 m²

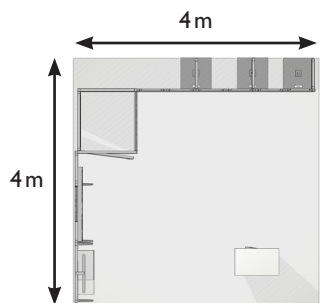

stand height 2,5m

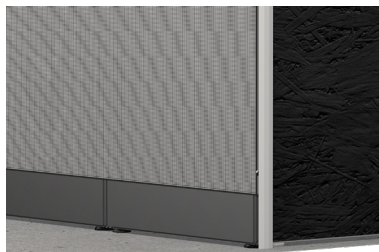

A bumper under each panel for perfect alignment

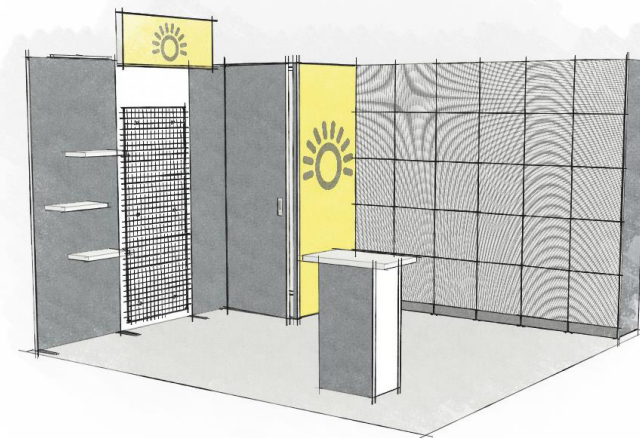

Create a storage space with our storage modules

Present your promotional items and fliers on the same panel



h-stand-18m2-31

Contact us to request a quote for a purchase or rental

Suggested transport solution
1 h-line HI crate

18 m²

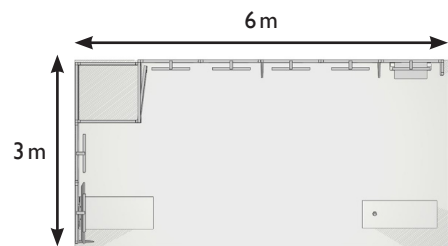

stand height 2,5m



HME017: shelf module with 3 brochure holders

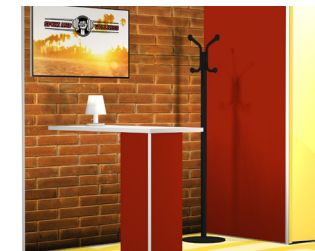

Console module HMC396B

Scalable to
12 m²



With one panel reversed and two modules removed
h-stand-12m2-16

Showcase your products with the helix.200 display case

Make your brand stand out with a lightbox sign



h-stand-18m2-24

Contact us to request a quote for a purchase or rental

Suggested transport solution
1 h-line H2 crate
+ 1 h-line H4 crate

18 m²

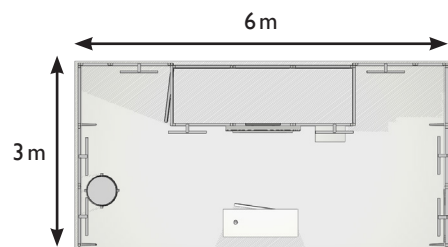

stand height 2,5 m



Accessories attached with universal attachment piece



wall-frame module HMF196

Scalable to 12 m²



Adapt your stand to a 12 m² space by removing three standard 96 modules and two standard 48

h-stand-12m2-24

Opt for a 65" TV

Increase your impact with an overhead backlit sign



h-stand-18m2-36

Contact us to request a quote for a purchase or rental

Suggested transport solutions

2 h-line H1 crates

+ 1 h-line H7 crate

18 m²

Two dedicated and independent discussion areas

6 m

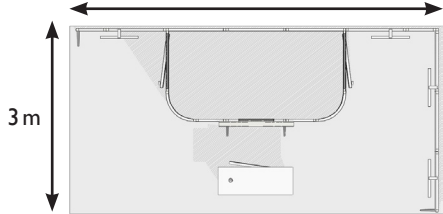

stand height 2,5 m



Lightbox counter module with door HMC196-L2

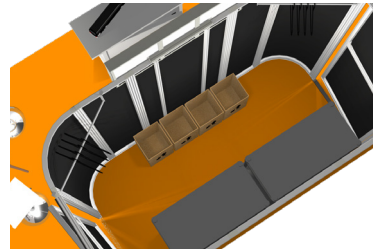

Large, secure storage equipped with 2 HAR001 kits

Scalable to in U

Reconfigure to a U-shaped booth by adding 3 standard 96 modules -

h-stand-18m2-35

Make your documents available to visitors

Light up your discussion spaces with a backlit canopy

h-stand-24m2-14

Contact us to request a quote for a purchase or rental

Suggested transport solution
2 h-line H2 crates

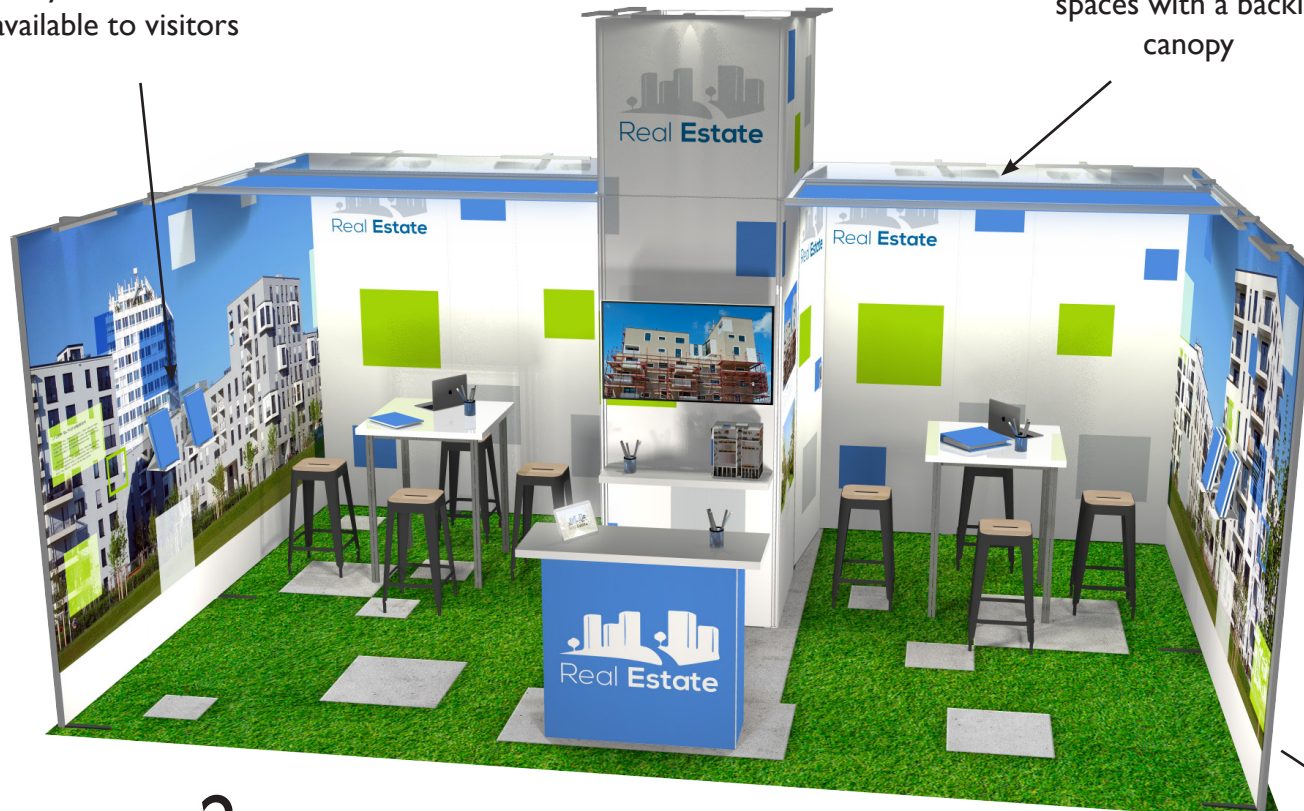

24 m²

6 m

4 m

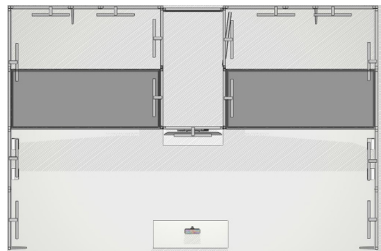

stand height 3,5 m



TV + shelving module HMM296A



Tablet holder



Scalable to
24 m²
island stand

A very different design in the same space!

h-stand-24m2-22

Broadcast your videos
with a curved arch + TV

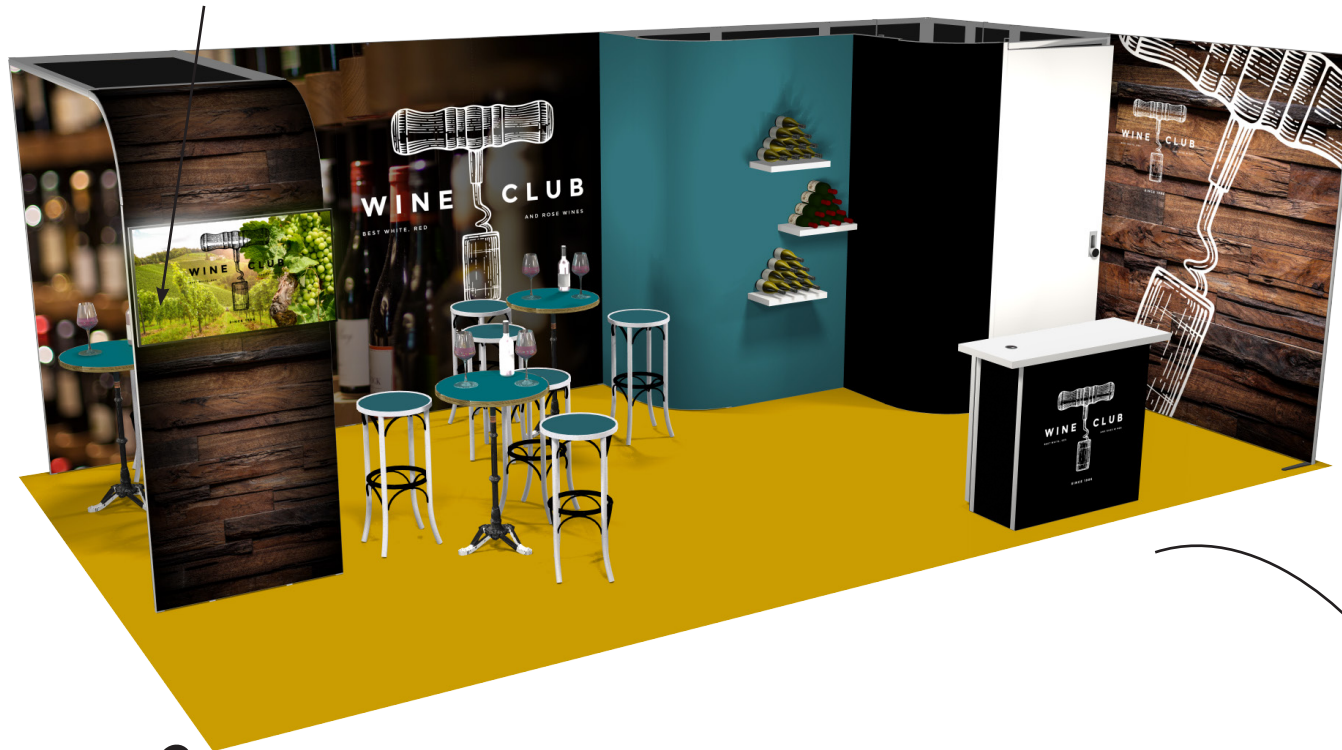

h-stand-28m2-01

Contact us to request a quote for a purchase or rental

Suggested transport solutions

- 1 h-line H1 crate
- + 1 h-line H4 crate
- + 1 h-line H7 crate

28 m²

7m

4m

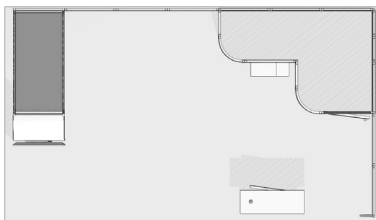

stand height 2,5m



Lightbox counter module with door HMC196-L2

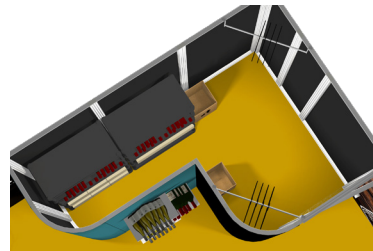

Large, fully-equipped storage



Scalable to
20 m²

Upgrade your booth to 20m² by removing 2 standard modules 96
h-stand-20m2-10

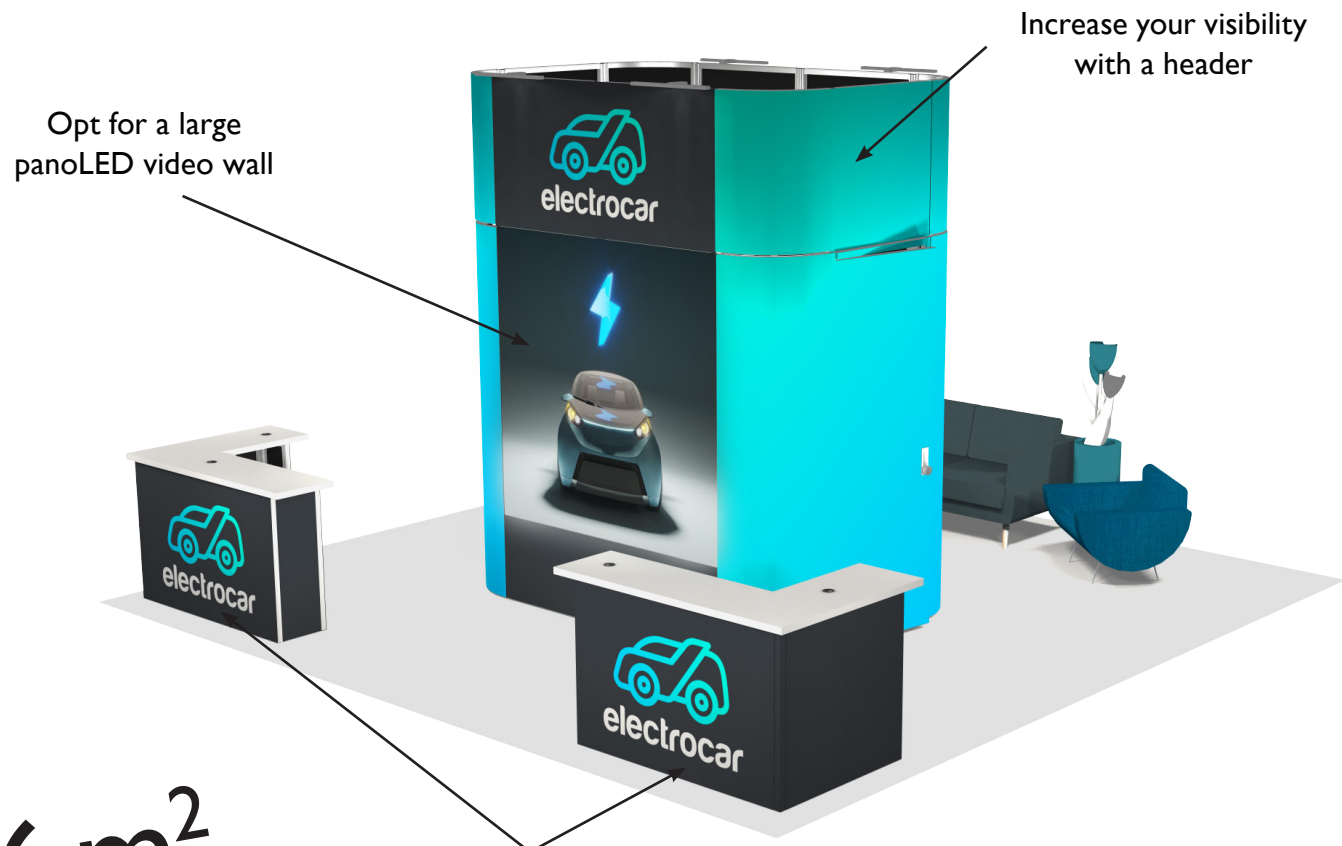

Increase your visibility with a header

Opt for a large panoLED video wall

Two independent reception areas

h-stand-36m2-02

Contact us to request a quote for a purchase or rental

Suggested transport solutions

- 2 h-line H1 crates
- + 1 h-line H2 crates
- + 1 h-line H4 crate
- + 2 flightcases for LED panels

36 m²

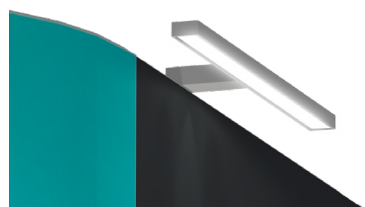
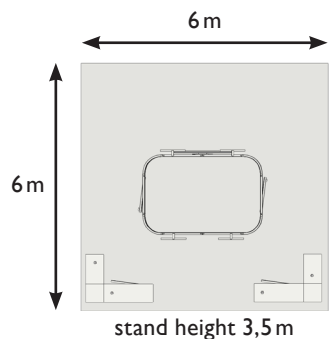

Signature LED

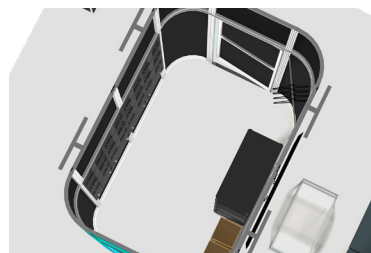

a large panoLED technical room equipped with HAR001



Large reception area with 65" TV

Opt for a round booth

Increase your visibility with a header

Large reception counter with the straight connector module



h-stand-64m2-01

Contact us to request a quote for a purchase or rental

Suggested transport solutions

- 1 h-line H1 crate
- + 1 h-line H4 crate
- + 3 h-line H7 crates

64 m²

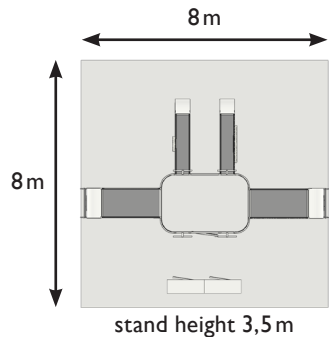

stand height 3,5m



Overhead backlit sign
HMH048-L and HMH120-L

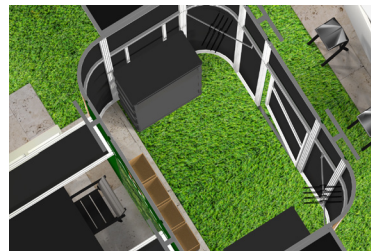

a large storage space equipped
with 2 HAR001 kits



Large reception area

Counters, to greet visitors!

panoramic®
h-line

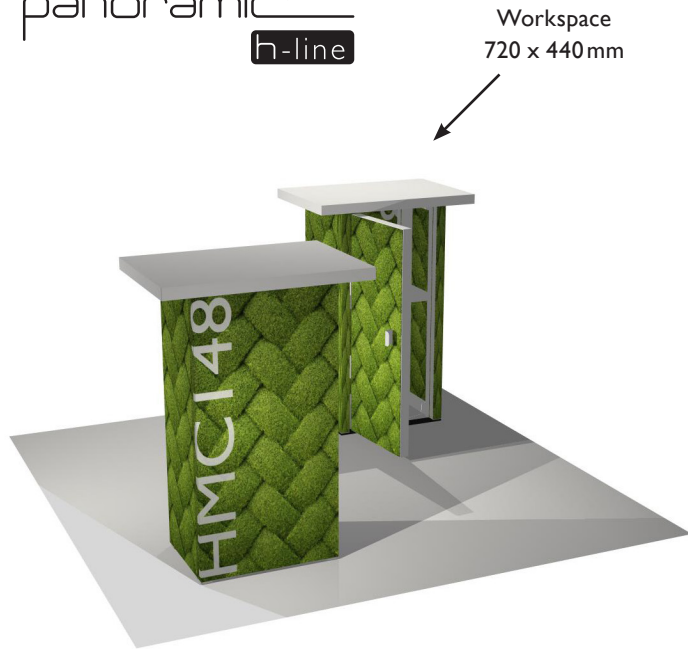

Workspace
720 x 440mm

Locking door



hmc148

S counter module with door
(48 x 96 x 30cm) + graphics

hmc148-usb

Option with USB hub

Counter height
1 000mm

hmc196

M counter module with door
(96 x 96 x 30cm) + graphics

hmc196-usb

Option with USB hub

Counter height
1 000mm

Lightbox Counter
panoramic®
h-line

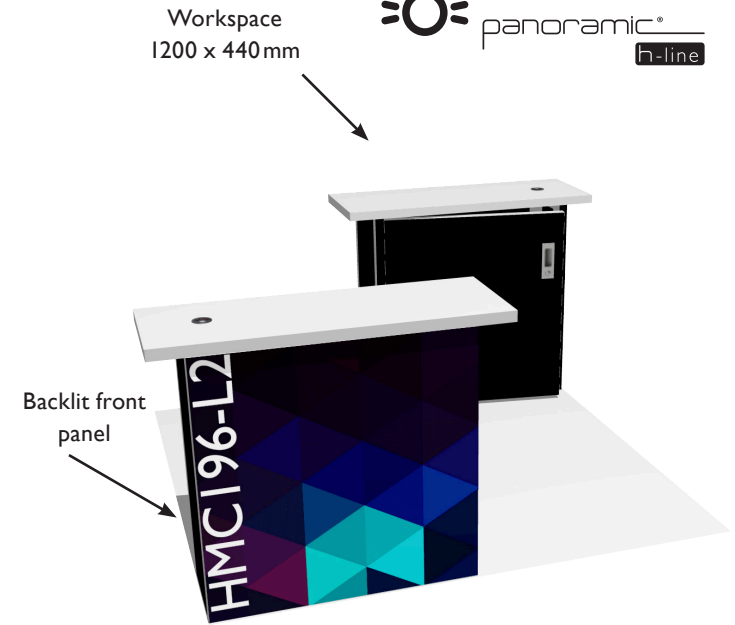

Workspace
1200 x 440mm

Backlit front
panel

hmc196-L2

M counter module with door and lighted front
(96 x 96 x 30cm) + graphics

hmc196-L2-usb

Option with USB hub

Counter height
1 000mm

panoramic h-line counters are usually sold with panoramic h-line stands.
Please contact us for individual packaging.

Travel solutions

panoramic®
h-line

Accessory storage

All of our wood crates are shock-resistant

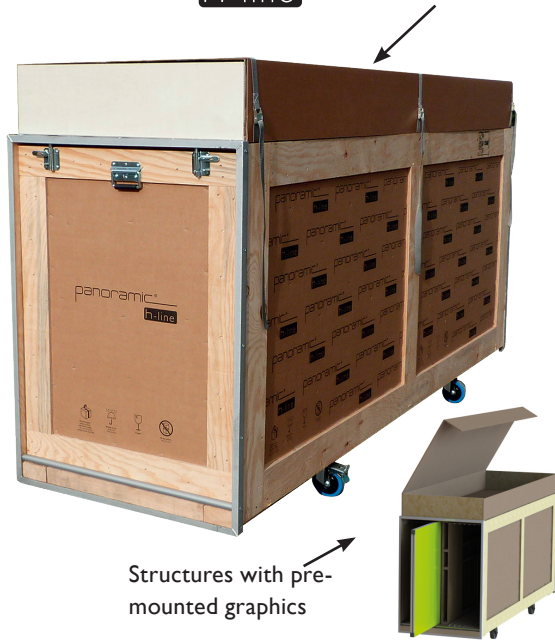

Structures with pre-mounted graphics



Partitionable crate



crate.h-line H1

Outer dimensions
W 820 x D 2 620 x H 1 420 mm

Weight
149 kg

Can hold up to 14 frames

crate.h-line H2

Outer dimensions
W 740 x D 2 620 x H 1 440 mm

Weight
110 kg

Can hold up to 12 frames

flightcase.panoLED

Outer dimensions
W 790 x D 594 x H 765 mm

Weight
55 kg

Can hold up to 10 LED panels (a 2,3 m² LED video wall)

crate.h-line H4

Outer dimensions
W 520 x D 2 650 x H 1 220 mm

Weight
80 kg

Can hold up to 8 frames



crate.h-line H7

Outer dimensions
W 2 606 x D 737,20 x H 409 mm

Weight
24 kg

Can hold up to 4 frames



Height includes wheels and accessories compartment.

Couldn't find the perfect configuration?
Let us create it for you!



Find more configurations in our stand library at <https://duodisplay.com/en/stand-library/>

duo.
STANDS & DISPLAYS

Stands modulaires

Cadres tissu

Stands sur-mesure

Stands portables & pop-ups tissu

Roll-ups & porte-bannières

Communication extérieure

Modularité Localisation

Produit Modules Transport

Design Sur-mesure

Star-Graphic Automatique





panoramic[®]
c-line



design

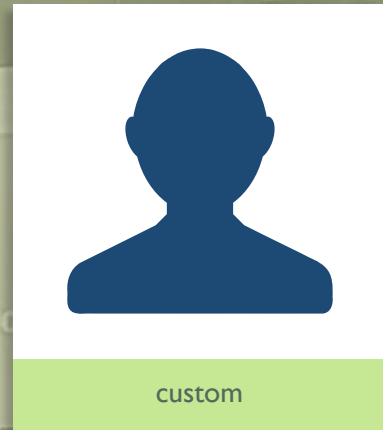

custom

- Custom stands, zero design commitments
- Reusable
- To be set up by installers

custom stands

Custom and creative stands



lightbox



New: integrate LED video walls



curved elements

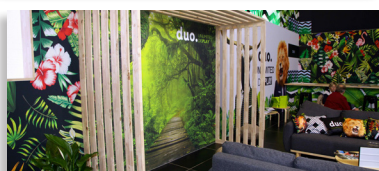

woodwork element integration



- Bring your ideas to life with panoramic: extra-large graphics, backlit walls, curved elements, woodwork element integration, heights over 5 m and more
- Innovate and bring your stand to life with panoLED video walls
- Panoramic stands are reconfigurable and reusable!
- Panoramic lightbox is endlessly customizable: choose from single- or double-sided options, profile colour choices, lightbox reverse side options, accessories, etc
- Panoramic lightbox is UL certified CE and UL .



9 m²

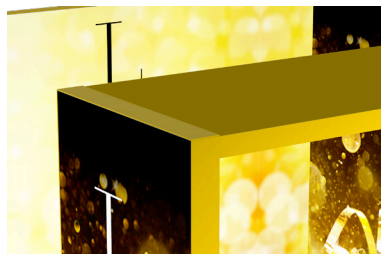

More immersion thanks to new profile colours

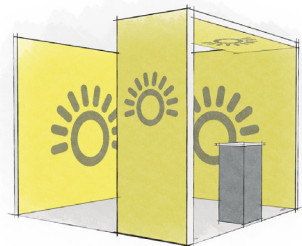

c-stand-L-54

Contact us to request a quote

Suggested transport solution

3 stackable crates

+ 1 simple flatbed trolley

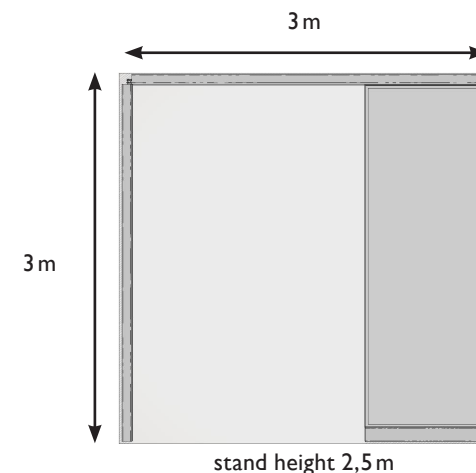



20 m²

c-stand-L-49

Contact us to request a quote

Suggested transport solution
3 stackable crates
+ 1 simple flatbed trolley



Lockable storage



Compact packaging

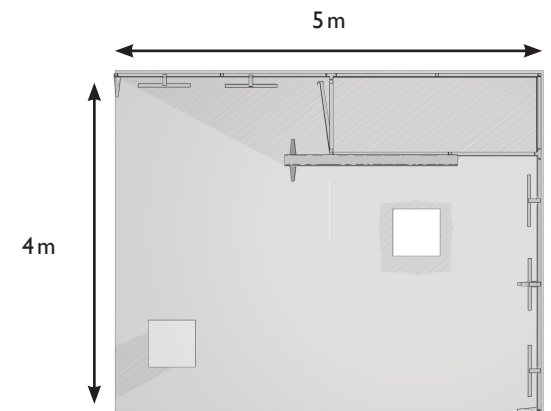
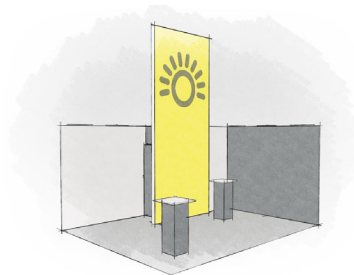

stand height 5 m



c-stand-L-53

Contact us to request a quote

Suggested transport solution
4 flightcases for LED panels
+ 5 stackable crates
+ 1 double flatbed trolley

36 m²



Attach shelves to your lightboxes

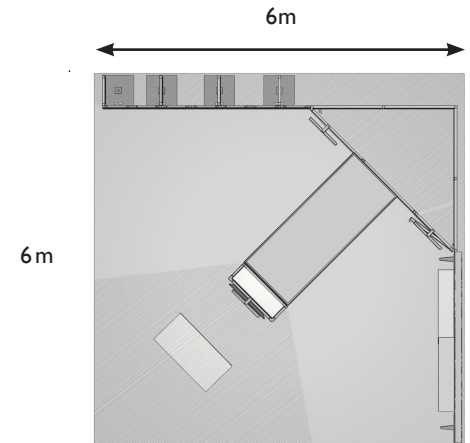
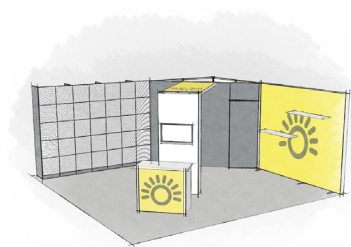

stand height 2,5m



36 m²



100% lighted corner



Backlit two-sided signage totems

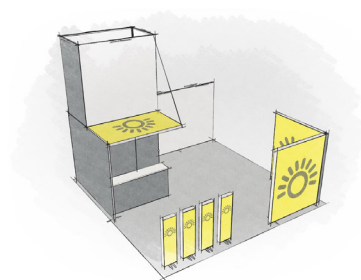

c-stand-L-52

Contact us to request a quote

Suggested transport solution

- 1 wood crate
- + 3 stackable crates
- + 1 simple flatbed trolley

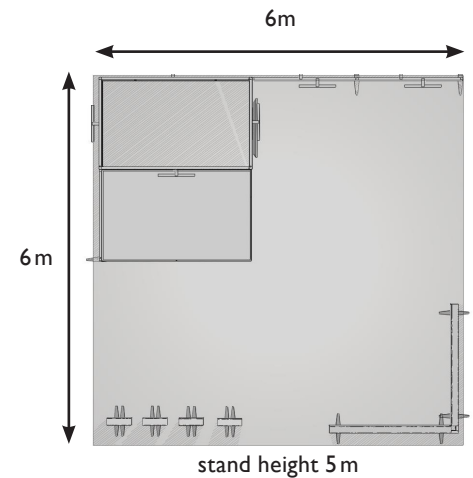



49 m²

c-stand-L-51

Contact us to request a quote

Suggested transport solution
 4 stackable crates
 + 1 double flatbed trolley



Classic wall.frame



Double-sided lightbox

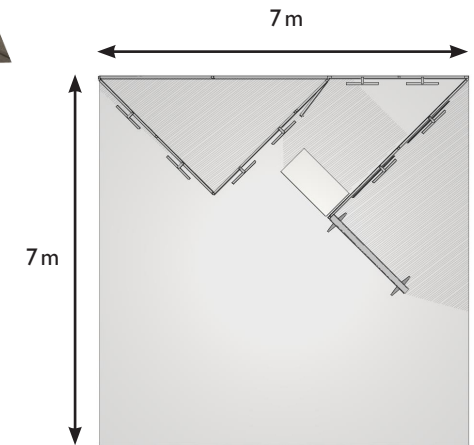
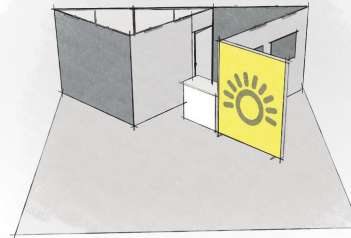

stand height 2,5 m



c-stand-L-50

Contact us to request a quote

Suggested transport solution
 | wood crate



100% lighted corners

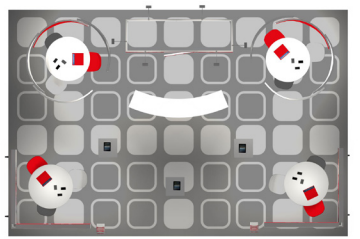

Printed carpet

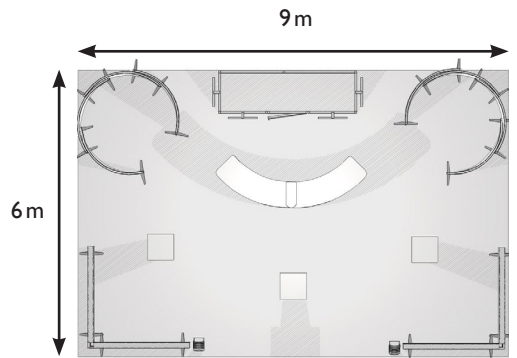
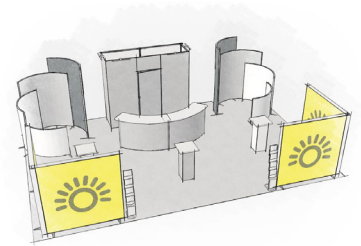

Meet around a
reception desk

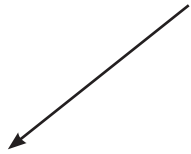

c-count-6

Structure + graphic + countertop
+ packaging*

Countertop dimensions

550 x 550 mm

Counter height

1 025 mm

c-count-7

Structure + graphic + countertop
+ shelf + packaging*

Countertop dimensions

545 x 1 810 mm

Counter height

1 025 mm

c-count-8

Structure + graphic + countertop
+ shelf + packaging*

Countertop dimensions

545 x 3 163 mm

Counter height

1 025 mm

*Custom cardboard packaging

panoramic®
C-line

Partitionable crates

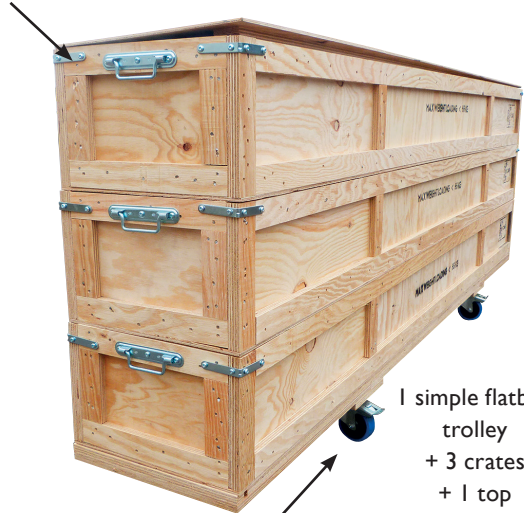

Locking wheels

1 simple flatbed trolley
+ 3 crates
+ 1 top

stackable.crate

Each crate is sold individually
Simple flatbed trolley for 1 to 3 carton crates, including 1 top
Double flatbed trolley for 1 to 6 carton crates, including 2 tops

Outer dimensions
W 400 x D 2575 x H 260mm

Weight
17kg



portable

Also available in a portable version



wheeled.bag TRB011

Outer dimensions
W 380 x D 340 x H 1350mm

Empty weight: 10kg
Max. load 30kg



soft.profile cover SOFT-BAG*

*maximum two profile covers per wheeled bag

Couldn't find the perfect configuration? Let us help you design it!

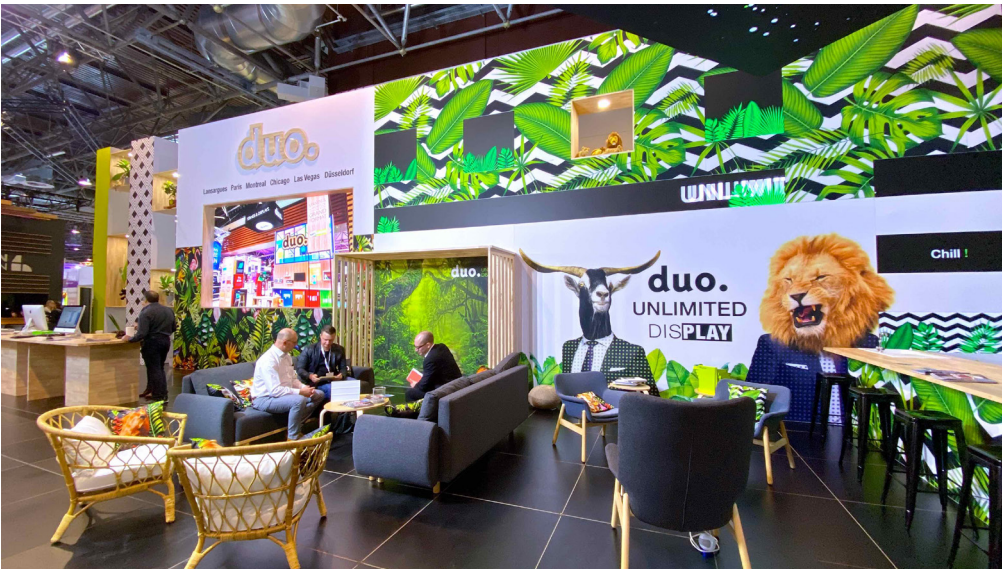

Find more configurations in our stand library at <https://duodisplay.com/en/stand-library/>

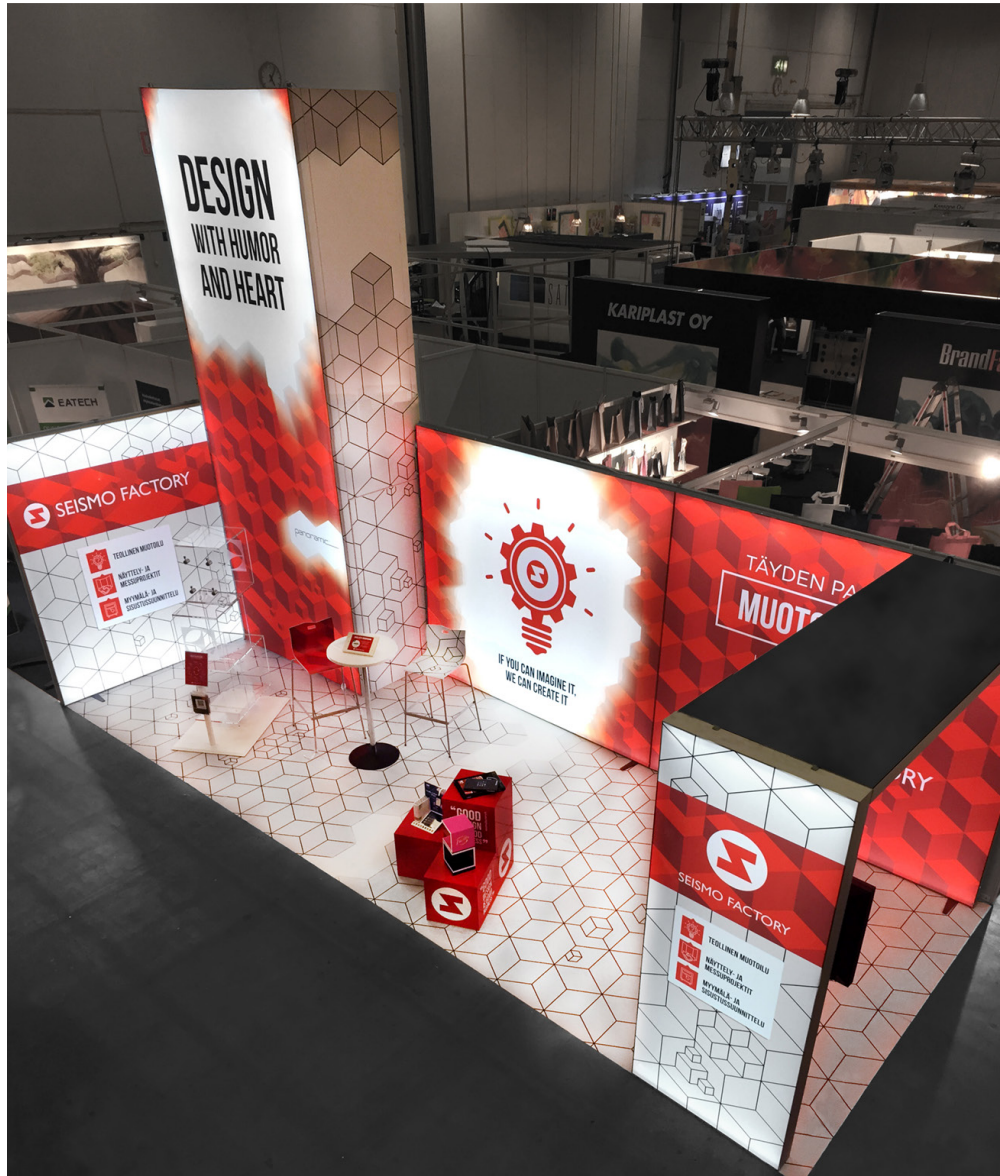



- These products are designed to complement your stand
- Printed carpets and hanging signs to create impact and a fully immersive environment
- Various light options to illuminate your stand
- Brochure holders and display cases let you store your documentation and showcase your objects

stand add-ons

Get noticed with hanging tubular signs!



- Tubular structure made with anodised aluminium completely covered with stretch fabric
- Excellent method for attracting attention, highlighting your message and adding height to your stand
- Choose your sign's shape, round or square, based on your stand's design
- Available for purchase or rental

square.sign

2X2X1

Structure + graphics*
+ 1 wheeled transport bag

Dimensions	Weight
2000 x 2000 x 1000	21 kg

2X2X1,5

Structure + graphics*
+ 1 wheeled transport bag

Dimensions	Weight
2000 x 2000 x 1500	24 kg

3X3X1

Structure + graphics*
+ 1 wheeled transport bag

Dimensions	Weight
3000 x 3000 x 1000	29 kg

3X3X1,5

Structure + graphics*
+ 1 wheeled transport bag

Dimensions	Weight
3000 x 3000 x 1500	34 kg

circular.sign

Ø 2X1

Structure + graphics*
+ 1 wheeled transport bag

Dimensions	Weight
Ø 2000 x 1000	15 kg

Ø 2X1,5

Structure + graphics*
+ 1 wheeled transport bag

Dimensions	Weight
Ø 2000 x 1500	17 kg

Ø 3X1

Structure + graphics*
+ 1 wheeled transport bag

Dimensions	Weight
Ø 3000 x 1000	18 kg

Ø 3X1,5

Structure + graphics*
+ 1 wheeled transport bag

Dimensions	Weight
Ø 3000 x 1500	20 kg

*Graphics printed on one side with black back or printed on both sides.

Hanging signs: out-exhibit the crowd!



- Help visitors find your location in a trade show and add height to be visible, even from a distance
- Aluminium structure with dye-sublimation printed graphic stretched over structure with SEG finishing
- Bottom panel can be added to square or rectangular sign
- Available for purchase or rental

cubic.sign



5-sided graphic wrapping

hsboo1

Structure + wires
+ graphics + packaging*

Dimensions
D 1 000 x W 1 000 x H 1 000mm

Weight
30 kg

Lighting option available

Weight
32 kg

hsboo2

Structure + wires
+ graphics + packaging*

Dimensions
D 2 000 x W 2 000 x H 1 500mm

Weight
46 kg

Lighting option available

Weight
55 kg

hsboo3

Structure + wires
+ graphics + packaging*

Dimensions
D 2 900 x W 2 900 x H 1 500mm

Weight
63 kg

Lighting option available

Weight
92 kg

rectangular.sign



5-sided graphic wrapping

hsroo1

Structure + wires
+ graphics + packaging*

Dimensions
D 1 000 x W 2 000 x H 1 000mm

Weight
36 kg

Lighting option available

Weight
40 kg

hsroo2

Structure + wires
+ graphics + packaging*

Dimensions
D 1 000 x W 3 000 x H 1 000mm

Weight
44 kg

Lighting option available

Weight
51 kg

hsroo3

Structure + wires
+ graphics + packaging*

Dimensions
D 2 000 x W 3 000 x H 1 000mm

Weight
50 kg

Lighting option available

Weight
65 kg

Lighting

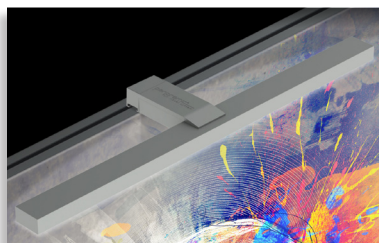

powerful, uniform lighting



discreet



easy attachment

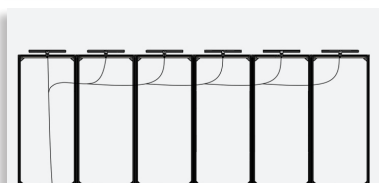

connect up to 24 lights
in a row

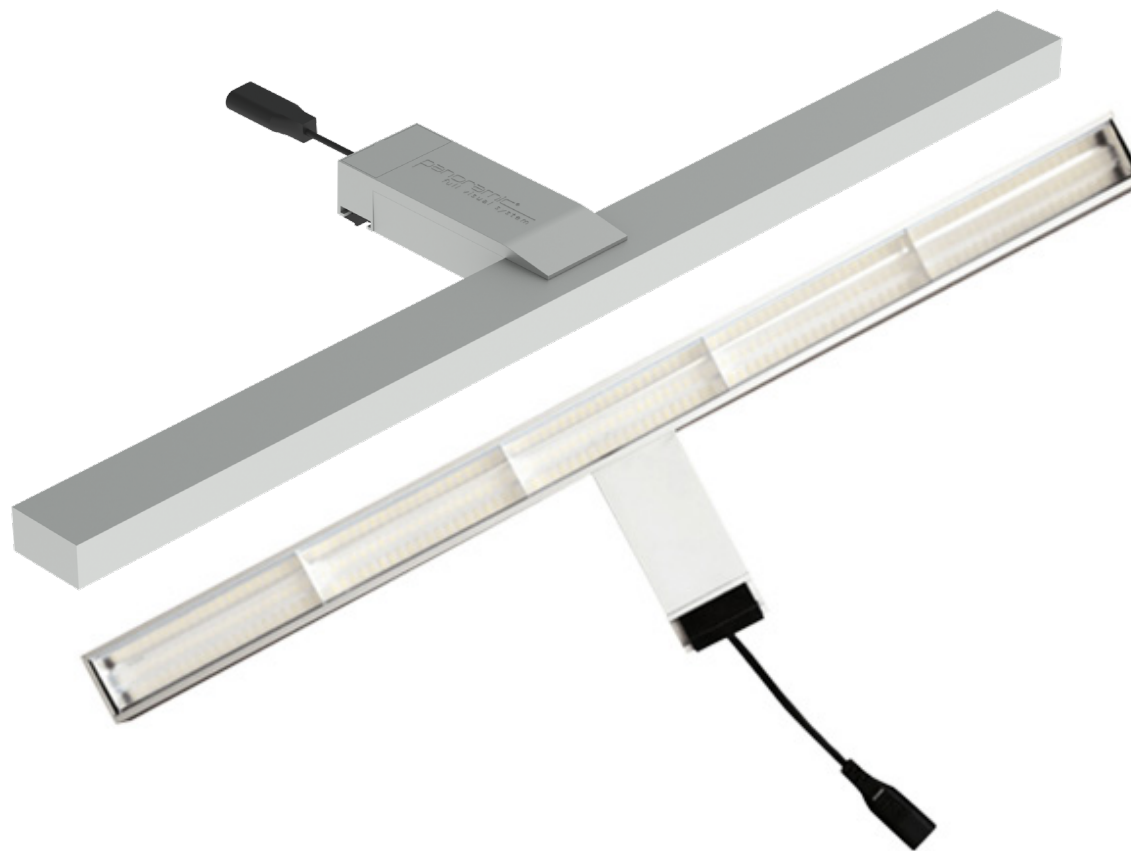

signature.spot

Signature spot 20W (transport bag included)

With its sleek, contemporary lines, it integrates flawlessly into all of your Panoramic stand designs. Your stand looks elegant and the spotlight is put on your image alone. Its elongated design ensures uniform lighting.



Lighting



spot.LED

LED spotlight 20W (includes transport bag)

The LED spotlight is brighter than a halogen spotlight and is much more energy-efficient!

Personalise your stand's floor with panofloor.2!

- Give your stand more personality and immerse your visitors in your world
- Large-format dye-sublimation printed carpet, available up to 3m wide without a seam
- Ideal for all your events, including fairs, trade shows, conferences, seminars



examples

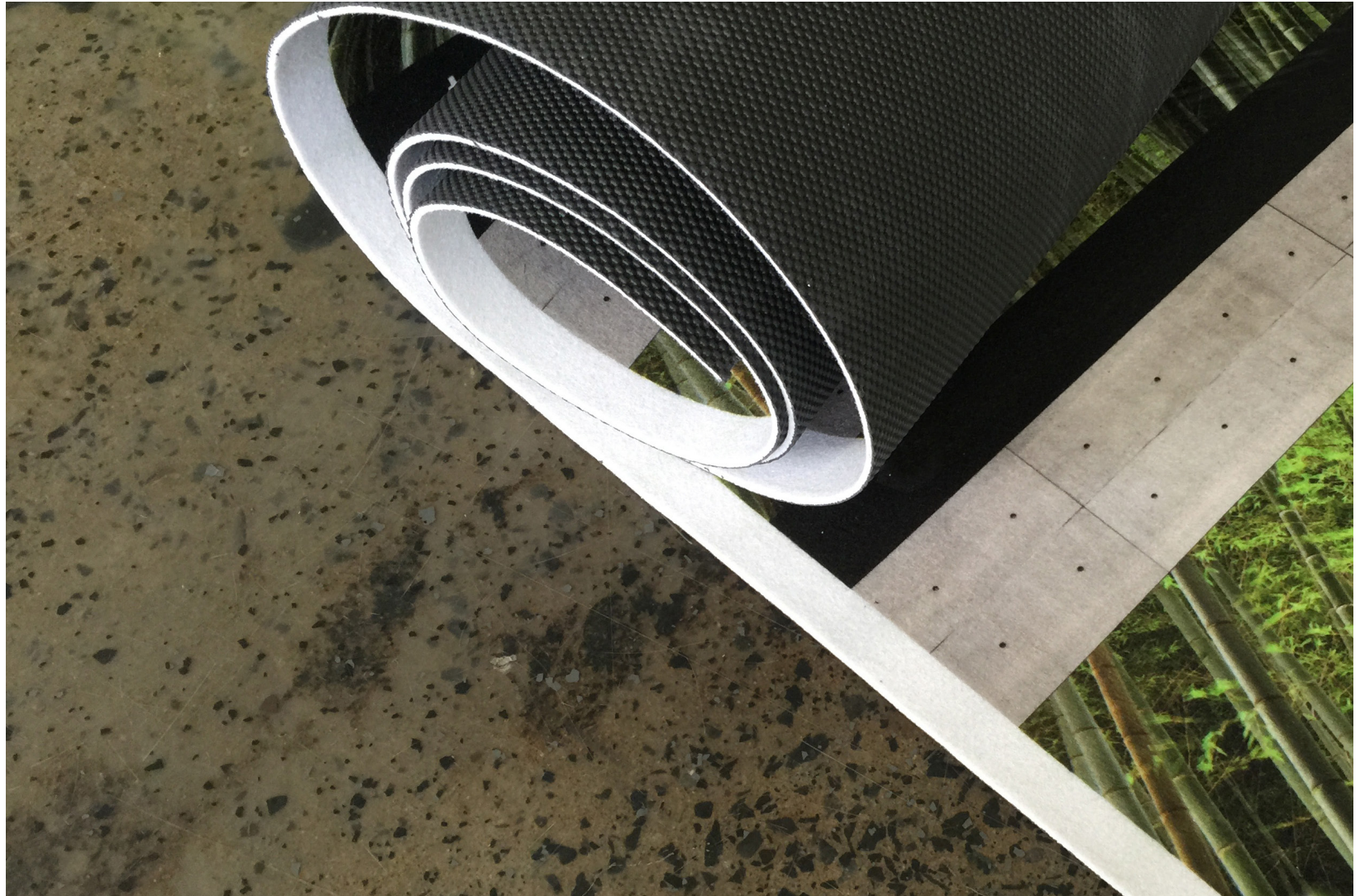

Brochure-holders & display cases



holdup.fabric4

Brochure holder with 4 fabric pockets (transport bag included)



holdup.fabric8

Brochure holder with 8 fabric pockets (transport bag included)



holdup.classic

Brochure holder with 4 polycarbonate pockets (transport bag included)

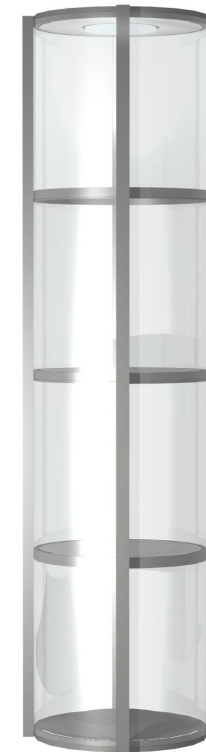

helix.200

Large illuminated foldable display case with 4 shelves and 16 transparent panels

Dimensions
Ø560mm x H 2000mm

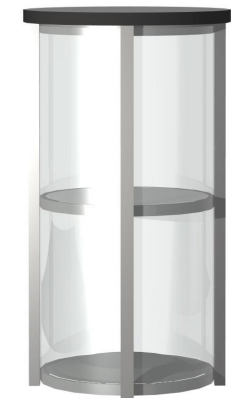

helix.106

Small foldable counter display case with 2 shelves and 8 transparent panels

Dimensions
Ø580mm x H 1060mm

Stand out from the crowd with a personalized, high-impact stand.

Our stand solutions, especially those from the panoramic line, are designed to highlight printed images. Here are a few creative tips to maximize your visual effectiveness.

- Opt for an immersive design

Optical illusion effects, textures, high-resolution and large-format graphics, graphic personalization of the entire surface including the floor...these are just some of the ways you can immerse your visitor in your stand's environment.



- Focus on a simple graphic and a unique message

Trade show visitors have less than 30 seconds of attention to give you when they pass by your stand. The easiest message for them to understand is a simple message set against a sleek graphic background. Try to avoid using too many messages, colors or effects, as impact is created through simplicity.



- Combine continuous design with modularity

Your modular stand will evolve as you attend various trade shows and share different messages. The languages of your event may even vary. Don't hesitate to adapt its design as necessary. We guarantee perfect graphic continuity, even if your stand is sectioned into panels.



To create your graphics, please refer to the provided templates to create the appropriate files, and contact our project management team at the start of your project. You will then be guided through our xpo.center file management platform.

Four reasons to attend a trade show

- Meet decision-makers

According to Exhibit Surveys, in 2010, 80% of trade show visitors had "the power to recommend or make final purchase decisions". In addition, 31% of visitors claimed that "their purchase intention was stronger after visiting the trade show".

- Improve sales productivity

According to the French Statistical Audit Bureau for General and Specialised Fairs and Exhibitions (OJS), customer contact at a trade show is "four to ten times less expensive than a customer visit". Contact cost for a stand averages at about 20 \$, whereas this contact ranges from 80 à 200 \$ when made during field visits. Furthermore, a sales rep will meet with 15 customers daily at a trade show vs. an average of three customers during a field visit.

- Explore prospects

Trade shows hold a wealth of opportunities and present many "hot" receptive prospects because visitors attend shows on their own accord. This makes it an incredibly effective way for exhibitors to expand their customer base

- Communicate with the press and opinion leaders

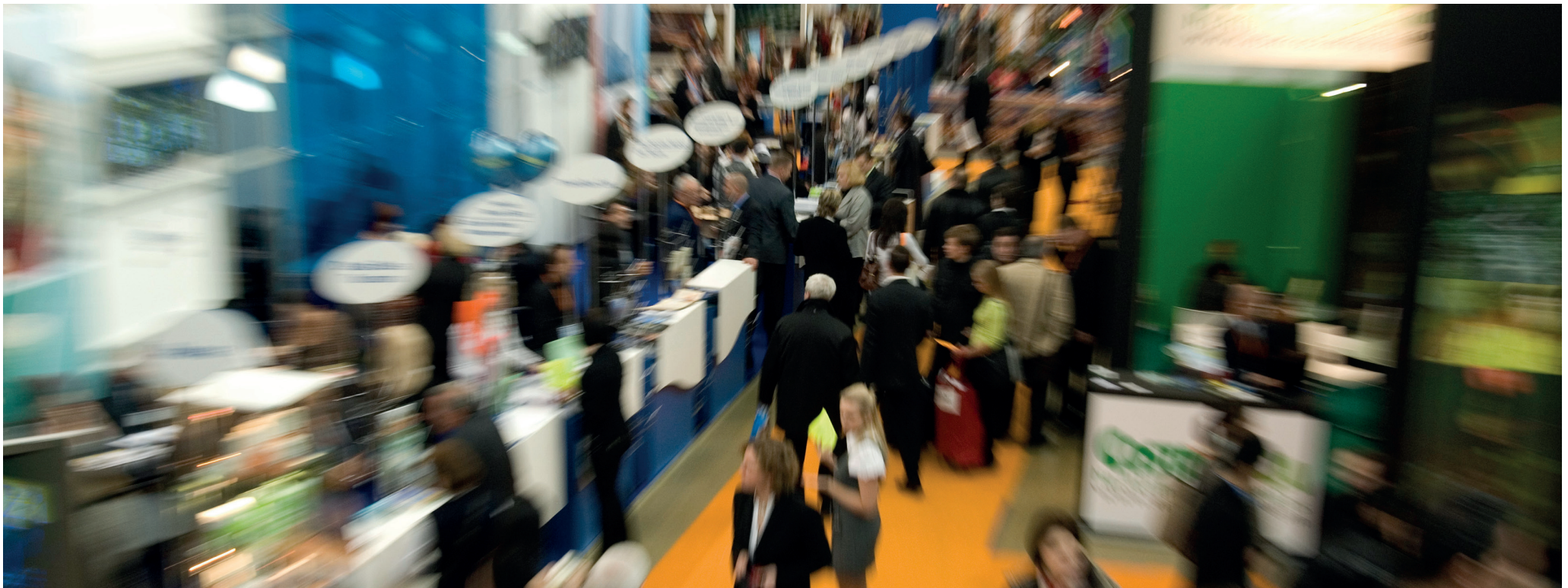

Tips & Tricks for a Successful Trade show

Before the show

- Create a budget and set goals

Trade show participation is part of a company's overall strategy, as well as its marketing, sales and HR strategies. It is very important to set specific goals and create a budget that includes purchasing of space, a stand, as well as personnel costs (travel, hotels, restaurants). It is essential to create a system for gauging the success of each trade show.

- Select trade shows that your company wants to attend, then choose your placement and area size

A countless array of events exist, ranging from major international trade shows to local conventions. It is important that each trade show you attend corresponds to your company's challenges in terms of business. Many companies now prefer to attend local trade shows with small exhibit areas as they offer more returns on investment.

Trade show organizers often offer pre-registration discounts, so it is best to reserve exhibit space in advance. Placement is also a very important factor.

Opt for placement near the entrance, in the main aisles or near "locomotives" (leading companies that attract visitors).

- Seek assistance of trade show display and visual communication professionals

Exhibits and event planning are very specific fields and require experience. Seek the advice of professionals, and do not hesitate to ask your service provider questions on how to set up your stand and who will be involved. You may also request references and contact them.

- Create a brief for trade show display professionals

Clearly explain your objectives and your strategy. Several constraints may influence your trade show display specialist's recommendations, which can help you cut costs significantly.

What type of stand should you choose? We have divided stands into three categories based on their weight, volume and assembly time/difficulty. The categories are: ultra-portable, portable and transportable. All ultra-portable and portable solutions may be set up and dismantled by exhibitors without any professional assistance. Some transportable stands also have the "Do it yourself" label.

How many times will you use your stand? If you will only use your stand once, opt for a rental. If you will reuse it several times, specify the various spaces where it will be used and your desired configurations. It is possible to start with a modular system that uses shared elements, which will allow you to create exhibits ranging in a wide variety of sizes.

Which features do you need? Reception counters, storage, product displays, videos, customer meetings, brochure distribution.... these are all features that influence how your stand is designed.

- Invite your customers and prospective customers

Trade show organizers provide free passes and distribute newsletters, which will allow you to easily inform your customers about your participation.

Sales teams can also increase their scope of action by meeting with customers before and after the trade show for breakfast or dinner.

Remember that these times are just as effective as field visits.

During the trade show

- **Details make the difference**

Your stand is a reflection of your company's image. Make sure it is organized! A storage area is very useful for concealing packaging or for storing brochures. Portable solutions come with a carrying case that turns into a counter, and modular solutions offer storage areas that are secured by a door. Lighting is very important as it puts the spotlight on your message. Environmentally-friendly LED solutions help conserve electricity.

- **Brief your teams every morning**

Your team should be informed about your new products and services.

A daily morning meeting before the show opens is a way to re-specify goals and answer questions that were asked the night before.

- **Create buzz around your stand**

To capture visitors' interest, create buzz around your stand with training sessions, wine & cheese samplings and other attention-drawing events.

After the trade show

- **Follow-up is the key to success**

A successful trade show is not just about meeting with customers and leads: Ensure that each lead has been addressed and a follow-up goal is established. Thank your customers after the trade show and follow up on each request individually. Ensure that each lead has been processed with an objective follow-up. You will then be able to gauge the show's success and decide whether or not you will attend it again in the future.

- **Reuse graphics after the trade show**

Exhibition systems like Panoramic allow you to use portions of your graphics, which can be cut or re-sewn.

The single-sided frame can be mounted on a wall, and the double-sided frame lets you create fabric backwalls, which are like mini-exhibition kits.



Find all Duo solutions with
our certified partners
and on shop.duodisplay.com

duodisplay.com/en

Lansargues

Paris

Düsseldorf

Montréal

Las Vegas